

SHEER HORIZONTAL & VERTICAL SHADINGS

Color Lux® Sheer Shadings / Shangri-La® Sheer Horizontal Shadings
Paradise™ Sheer Shadings / Vertical Sheer Shadings / Overtones™ Dual Sheer Shades

2021

UPDATED 09/07/2021



Sheer - Effective 02.01.2021 | 518100PL1
Shangri-La Sheer Horizontal Shadings/Soft Tones Sheer Shadings/Vertical Sheer Shadings/ Overtones Sheer Shades/Paradise Sheer Shadings

Version 1	Original Price List effective February 1, 2021	UPLOADED 12/15/2020			
Version 2	Color Lux Sheer Retractable Cord Specs (page 2 & 5) Updated: Width 12" to 120" & Length 12" to 72" Same as Shangri-La Sheer Retractable Cord specs (page 32)	Updated 01/04/2021			
Version 3	<ul style="list-style-type: none"> •Cordless & Retractable cord surcharge changed from \$108 to \$106 on Pages 39-41 •Paradise Sheer Shadings spec page 62, a SqFt size restriction has been added onto motorized shades (inc. Powertouch) LF fabrics: max 60 sqft & RD fabrics: max 50 sqft 	Updated 01/14/2021			
Version 4	Remove page references (Pages 104 & 106)	Updated 01/26/2021			
Version 5	Added Plug-In Charger on surcharge graph to the Rechargeable PowerTouch Wand System to clear up any confusion (Page 7 & 37)	Updated 01/27/2021			
Version 6	Corrected surcharge for Rechargeable with Integrated Battery Pack to \$188 (page 96)	Updated 01/29/2021			
Version 7	Page of PL version and their changes added to PDF	Updated 02/16/2021			
Version 8	TOC updated and expanded Page 18, 12v low volt hardwire option added to Color Lux Sheer Shadings	Updated 02/17/2021			
Version 9	Prices Increased Effective 8-24-2021 (OverTones excluded)	Updated 06/24/2021			
Version 10	Metallic Surcharge updated on page 8	Updated 06/25/2021			
Version 11	Bluetooth Availability Chart Updated (pg 18)	Updated 07/02/2021			9/7/2021
Version 12	Solar LED lights Added (page 25)	Updated 07/28/2021			
Version 13	Grid 7 (pg 40) hardware availability updated	Updated 09/07/2021			

Comfortex Color Lux® Sheer Shadings, Shangri-La® Sheer Horizontal Window Shadings, Paradise™ Sheer Shadings, Vertical Sheer Shadings and Overtones™ Dual Sheer Shades Price List and Reference Guide

Effective February 1, 2021 | Updated 09/07/2021 | New Prices Effective 8/24/21

This price list and reference guide contains product pricing, product specifications and technical information for the complete line of Comfortex Color Lux Sheer Shadings, Shangri-La Sheer Horizontal Shadings, Paradise Sheer Shadings, Vertical Sheer Shadings and Overtones Dual Sheer Shades.

COLOR LUX SHEER SHADINGS	Page
Features At A Glance	1
Key Features	2-3
Fabric Collections and Vane Sizes	4
Fabric Collection Size Standards	5-6
Hardware Upgrades and Surcharges	7

Color Lux Sheer Shadings Pricing Grids

3" Light Filtering	Price Group 1	8
3" Room Darkening	Price Group 2	8
3" DoorStyles Light Filtering	Price Group 3	9
3" DoorStyles Room Darkening	Price Group 4	9

Color Lux Sheer Shadings Hardware

Cord Loop Designer Cassette Head Rail:	10-11
Cord Information for Color Lux Sheer Shadings	11
Reverse Roll	11
Length Considerations with Color Lux Sheer Shadings	11
Side by Side Alignment	11
Omni-View System	11
Retractable Cord	12
Two-On-One	13
Cordless	14-15
DoorStyles	16-17
NEW Simplicity Remote Control  Bluetooth® Motorization	18
7.4V PowerTouch Rechargeable Motorization	19-20
12V Non-Rechargeable Simplicity Motorization	21-22
7.4V Rechargeable Simplicity Motorization	23-25
Solar Panel Recharge Option	25
7.4V EZ Charge Extension Wand	26
12V Simplicity Low Voltage Hardwired System	27
Simplicity Smart Controller	28
Certified Fabrics	29
Flame Resistance and Visibility	29
Vane Closure	29
Leveling Color Lux Sheer Shadings	29
Measuring Instructions for Color Lux Sheer Shadings	30
Skew Adjusting Bottom Rail	30
Cleaning and Care	30

SHANGRI-LA SHEER HORIZONTAL SHADINGS	Page
Product Overview	31
Key Features	32-33
Hardware Options/Availability	34
Size Standards	35-36
Upgrade Options/Surcharges	37
Pricing Examples	38

Shangri-La Sheer Horizontal Pricing Grids

2" Light Filtering	Price Group 5	39
2" Room Darkening	Price Group 6	39
2½" Light Filtering	Price Group 7	40
2½" Room Darkening	Price Group 8	40
3" Light Filtering	Price Group 9	41
3" Room Darkening	Price Group 10	41
2" DoorStyles Light Filtering	Price Group 11	42
2" DoorStyles Room Darkening	Price Group 12	42
3" DoorStyles Light Filtering	Price Group 13	43
3" DoorStyles Room Darkening	Price Group 14	43

Hardware Systems

Cord Loop Hardware Specifications:.....	44
Retractable Cord Hardware Specifications.....	45
Cordless Hardware Specifications	46-47
Shangri-La DoorStyles Hardware Specifications	48-49
7.4V PowerTouch Rechargeable Hardware Specifications	50-51
12V Simplicity Motorization Hardware Specifications	52-53
7.4V Simplicity Integrated Rechargeable Hardware Specifications.....	54-56
Two-On-One Hardware Specifications.....	57

General Hardware & Specifications

Cord Information for Shangri-La Shadings.....	58
Reverse Roll	58
Length Considerations with Shangri-La Shadings.....	58
Side by Side Alignment	58
Omni-View System	58
Braid Cord Loop Warranty	58
Certified Fabrics	59
Flame Resistance	59
UV Protection	59
Vane Opening and Visibility	59
Vane Closure	59
Leveling Shangri-La Sheer Horizontals	59
Skew Adjusting Bottom Rail.....	60
Highlights Cornice Valance.....	108
Cleaning and Care	109
7.4V EZ Charge Extension Wand.....	26
12V Simplicity Low Voltage Hardwired System.....	27
Simplicity Smart Controller	28

	Page
Measuring Instructions for Shangri-La Sheer Horizontals	110
Child Safety	111

PARADISE™ SHEER SHADINGS

Product Overview	61
Paradise Sheer Shadings Size Standards	62
Upgrade Options/Surcharges	62

Paradise Sheer Shadings Pricing Grids

2" Light Filtering	Price Group 15	63
2" Room Darkening	Price Group 16	63
2½" Light Filtering	Price Group 17	64
2½" Room Darkening	Price Group 18	64
3" Light Filtering	Price Group 19	65
3" Light Filtering	Price Group 20	65

Hardware Systems

Paradise Cord Loop Sheer Shadings Hardware	66
Length Considerations with Paradise Sheer Shadings	67
Side By Side Alignment	67
Vane Opening And Closure	67
Paradise Sheer Shadings Operation	68
Shading Adjustment	68
UV Protection	68
Cleaning and Care	109
Paradise Sheer Shadings Detailed View	70
Paradise Cordless Sheer Shadings Hardware	71-72
Paradise Cordless Sheer Shadings Detailed View	73
Paradise Retractable Cord Sheer Shadings Hardware	74
Paradise Retractable Cord Sheer Shadings Detailed View	75
Paradise PowerTouch Rechargeable	76-77
Paradise PowerTouch Rechargeable Sheer Shadings Detailed View	78
Simplicity Integrated Rechargeable	79-80
Paradise Integrated Rechargeable Sheer Shadings Detailed View	81
Paradise Options Additional Notes	82
Measuring Instructions	110

VERTICAL SHEER SHADINGS

Product Overview	83
Vertical Sheer Size Standards	84
Panel Designs Finished Dimensions	84

Vertical Sheer Shadings Pricing Grids

3½" Light Filtering	Price Group 21	85
3½" Room Darkening	Price Group 22	85

General Hardware & Specifications

Product Configurations	46
------------------------------	----

	Page
Vertical Sheer Shadings Fabric and Vanes.....	87
Tiltback.....	87
Vertical Sheer Shadings Hardware	88
Controls and Control Placement.....	88
Vertical Sheer Shadings Design and Operation	89
Vane Closure Gap.....	89
Split Stack Center Gap.....	90
Side by Side Abutted Applications.....	90
Abutted Gap.....	90
Return Gap	90
Measuring, Mounting Requirements and Installation Information	91-93
How to Avoid Common Ordering Errors.....	93
Stackback.....	94
UV Protection	94
Cleaning and Care.....	109
Child Safety.....	111

OVERTONES™ DUAL SHEER SHADES

Product Overview	96
Overtones Dual Sheer Shades Size Standards.....	97
Overtones Dual Sheer Shades Fabric Specifications.....	98

Overtones Dual Sheer Shades Pricing Grids

Crepe 3" and Herringbone 3¼" Translucent.....	Price Group 23	99
Barneget 3", Interweave 4", Marsheen 3", Studio 3", Valdese 3⅝" & Victoria 3¾" Translucent.....	Price Group 24	99
Band 2¾", Merino 3", Merino Wide 3¾" & Silk Strata 3" Translucent....	Price Group 25	99
Brushed 4", Essex 4", Zigzag 4" Room Darkening & Rain 3⅞" Translucent ...	Price Group 26	100
Bamboo 4⅞", Bistro 2¾", Boutique 3", Chevron 3", Heritage 3", Janka 3" Wave 3⅞" Translucent and Modish 3" Room Darkening.....	Price Group 27	100
Ambrosia 4" Room Darkening, Galaxy 3", Orion 5½" and Silver Lining 3" Translucent	Price Group 28	100

Hardware Systems

Overtones Dual Cord Loop Shades Hardware	101
Cleaning and Care.....	102
Overtones Dual Shades Operation.....	102
Overtones Dual Shades Detailed View	103
PowerTouch Rechargeable.....	104-105
Simplicity Integrated Rechargeable	106-107
Measuring Instructions.....	110

Policy & Warranty







Highlights Cornice Valances	108
Cleaning And Care.....	109
Measuring	110
Child Safety.....	111
Conditions of Sale	112
Policies.....	112
Vertical & Horizontal Warranty Information	113
Limited Lifetime Warranty	113
Motorized Shadings Warranty.....	114

COLOR LUX® SHEER SHADINGS

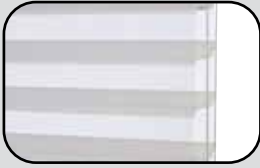

- Color Lux Sheer Shadings are a window shading of unique beauty and performance for the finishing touch to a beautiful window and room.
- Horizontal fabric vanes float between two layers of soft, knitted fabric sheers to soften your view outside.
- Color Lux Sheer Shadings are available to widths of 120" and drops to 132".
- Color Lux Sheer Shadings are available in 3-inch vane widths in both light filtering and room darkening fabrics.
- The sophisticated 25 patterns of white on white Color Lux Printed Sheer Shadings is designed to flatter your decor.
- All Color Lux Sheer Shadings, printed and solid colors, will have fabric wrapped head rail and bottom rail.
- Vanes glide from open to closed to out of sight with elegant hardware.
- Choose from multiple hardware options to customize your shading: traditional cord loop, retractable cord, cordless, PowerTouch with Touch and Go feature or Simplicity Integrated Rechargeable Motorization.
- Only the Omni-View cord system provides five distinctly different variations of vane position for numerous combinations of privacy, view and light control.
- Only with Color Lux Sheer Shadings, can you partially raise the shading with the fabric vanes in the open, view-through position so you keep your view and still feel the outdoor breeze.
- Create your customers own sophisticated look with the low light gap Designer Cassette Head Rail.
- Easy to install hardware and brackets allow for effortless installations and easy removal for cleaning.
- Color Lux Sheer Shadings may be ultrasonically or traditionally cleaned to stay bright and beautiful.
- A Limited Lifetime Warranty serves as a commitment to your satisfaction.



Color Lux® Sheer Shadings HARDWARE OPTIONS

	Key Features	Color Options	Head Rail Size (Depth x Height)	Shade Size Available	More Information
Cord Loop 	<ul style="list-style-type: none"> • Cord Loop makes operation easy • Smooth & quiet operation • Braided cord loop is used to raise and lower the shading • Bead Cord is optional 	<ul style="list-style-type: none"> • Fabric Wrap is Standard • White • Ivory • Onyx Black • Oil Rubbed Bronze • Brushed Nickel 	Fabric Wrapped: 3¾" x 2¾"	Width: 12" to 120"* Length: 12" to 132"***	Page 11
Retractable Cord 	<ul style="list-style-type: none"> • Single Cord Design • Provides easy one hand operation • Maintains a consistent cord length • Enhances child and pet safety 	<ul style="list-style-type: none"> • White • Black • Bronze 	Fabric Wrapped: 3¾" to 2¾"	Width: 12" to 120"* Length: 12" to 72"	Page 13
Cordless Shading 	<ul style="list-style-type: none"> • Cord Free • Roller catch mechanism in the head rail • Vanes easily adjusted into various positions 	<ul style="list-style-type: none"> • Clear handle • Bottom Rail is fabric wrapped 	Fabric Wrapped: 3¾" to 2¾"	Width: 20" to 84" Length: 18" to 96"	Page 15
12V Non-Rechargeable Simplicity Motorization 	<ul style="list-style-type: none"> • Raise & lower shade with click of a button • Great for large and hard to reach windows • Remote can operate multiple shades • Bluetooth available 	<ul style="list-style-type: none"> • Designer Cassette options • 5 Channel Black or White Remote • 6 Channel white Remote with timer • 14 Channel white Remote with timer 	Fabric Wrapped: 3¾" to 2¾"	Width: 14" to 120"* Length: 12" to 132"***	Page 21
7.4V Rechargeable Simplicity Motorization 	<ul style="list-style-type: none"> • Features a battery powered motor utilizing a rechargeable integrated battery pack • Raise & lower shading with click of a button • Great for large and hard to reach windows • Remote can operate multiple shades • Bluetooth available 	<ul style="list-style-type: none"> • Designer Cassette options • 5 Channel Black or White Remote • 6 Channel white Remote with timer • 14 Channel white Remote with timer 	Fabric Wrapped: 3¾" to 2¾"	Width: 19" to 120"* Length: 12" to 132"***	Page 23
7.4V Rechargeable PowerTouch 	<ul style="list-style-type: none"> • Raise & lower shading with push of a button • Eliminate the need to stand by the shading to operate; just touch and go • Favorite position button • Rechargeable battery with recharge port on pendant 	<ul style="list-style-type: none"> • Wand and pendant available in white or black 	Fabric Wrapped: 3¾" x 2¾"	Width: 18" to 120" Length: 12" to 132"	Page 19

* Maximum width of 120" IB, 119¾" OB

** Light Filtering 132", Room Darkening 122"

Color Lux® Sheer Shadings
HARDWARE OPTIONS

	Key Features	Color Options	Hardware Size (Depth x Height)	Shade Size Available	More Information
<p>DoorStyles</p>  <p>(Printed Sheer ONLY)</p>	<ul style="list-style-type: none"> • Great option for narrow windows and doors • Does not raise/lower, articulate vanes only • No Pull cords • Secure to door with hold down brackets 	<ul style="list-style-type: none"> • Rails and end caps are coordinated to the fabric color 	<p>2" x 1/2"</p>	<p>Width: 6" to 72"</p> <p>Length: 12" to 72⁺"</p>	<p>Page 17</p>
<p>Highlights Cornice Valance</p> 	<ul style="list-style-type: none"> • Adds height to windows and hides hardware • Available as inside and outside mount • Easy to install 	<ul style="list-style-type: none"> • All Color Lux Roller Fabrics • All Envision Roller Fabrics 	<p>Width: 24" to 216"</p> <p>Height: 6"</p> <p>Returns: 1 1/2" to 6"</p>	<p>Varies by selected fabric</p> <p>Width: 12" to 94"</p>	<p>Page 108</p>

* Maximum length varies by width

Color Lux® Sheer Shadings FABRIC COLLECTIONS

Color Lux Printed Sheer Shadings are available with different fabric collections.

COLLECTION	3" Vanes
Light Filtering	•
Room Darkening	•

Please Note: Room Darkening fabrics are not blackout fabrics. Knitted fabric may experience minor weave variations due to heat, humidity and other room conditions. These variations can result in light bowing, puckering and dimpling of the Shangri-La material. This is considered normal and does not constitute a failure in either workmanship or materials. The possible variations are minor and have been shown through case study not to detract from the beauty of the product.

Color Lux® Shangri-La Sheer Horizontal Shadings HARDWARE OPTION AVAILABILITY

Use this table to ensure your coordinating options and unique shapes are consistent with your product selections.

CORD LOOP	3" Vanes	Bluetooth
Cord Loop	•	NA
Cord Loop Two-On-One	•	NA
RETRACTABLE CORD		
Retractable Cord	•	NA
Retractable Cord Two-On-One	•	NA
CORDLESS SHADING		
Cordless Shading	•	NA
Cordless Shading Two-On-One	NA	NA
SIMPLICITY MOTORIZATION		
Simplicity Motorization	•	•
Simplicity Motorization Two-On-One	•	•
SIMPLICITY RECHARGEABLE MOTORIZATION		
Simplicity Rechargeable	•	•
Simplicity Rechargeable Two-On-One	•	•
POWERTOUCH RECHARGEABLE MOTORIZATION		
PowerTouch Rechargeable	•	NA
PowerTouch Rechargeable Two-On-One	•	NA
DOORSTYLE		
DoorStyle Prints Only	•	NA



Fabric Wrapped is Standard



Metallic Hardware Upgrades



Bottom Rail Partly Opened
(Bottom Rail is always fabric wrapped)



Bottom Rail Closed

Color Lux® Sheer Shadings
SIZE STANDARDS



		Cord Loop	Retractable Cord	Cordless Shading
ALL FABRICS	Minimum Width	12"	12"	20"
	Minimum Length	12"	12"	12"

Light Filtering	Price Group	Page		Cord Loop	Retractable Cord	Cordless Shading
3" Vanes	1	9	Maximum Width & Length	120"* x 132"	120"* x 72"	84" x 96"

Room Darkening	Price Group	Page		Cord Loop	Retractable Cord	Cordless Shading
3" Vanes	2	9	Maximum Width & Length	120"* x 122"	120"* x 72"	84" x 96"

				Cord Loop	Retractable Cord	Cordless Shading
More Information On Page				Page 11	Page 13	Page 15

* Maximum width of 120" IB, 119¾" OB



		DoorStyles
ALL FABRICS <i>Printed Sheer Only</i>	Minimum Width	6"
	Minimum Length	12"

Light Filtering	Price Group	Page		DoorStyles	Room Darkening	Price Group	Page		DoorStyles
3" Vanes <i>Printed Sheer Only</i>	3	10	Maximum Width & Length	72" x 96"*	3" Vanes <i>Printed Sheer Only</i>	4	10	Maximum Width & Length	72" x 96"*

		DoorStyles
More Information On Page		Page 17

* Maximum length varies by width. Maximum length for doorstyles over 36" wide is 72".

Color Lux® Sheer Shadings
SIZE STANDARDS

COLOR LUX SHEER SHADINGS



		Motorization	Motorization	Motorization	Two-On-One
		Bluetooth 7.4V Rechargeable Simplicity	12V Non-Rechargeable Simplicity	7.4V Rechargeable PowerTouch	
ALL FABRICS	Minimum Width	19"	14"	18"	See Table Below*
	Minimum Length	12"	12"	12"	12"

				Motorization	Motorization	Motorization	Two-On-One
				Bluetooth 7.4V Rechargeable Simplicity	12V Non-Rechargeable Simplicity	7.4V Rechargeable PowerTouch	
Light Filtering	Price Group	Page					
3" Vanes	1	9	Maximum Width & Length	120"* x 132"	120" x 132"	120"* x 132"	140" x 132"

				Motorization	Motorization	Motorization	Two-On-One
				Bluetooth 7.4V Rechargeable Simplicity	12V Non-Rechargeable Simplicity	7.4V Rechargeable PowerTouch	
Room Darkening	Price Group	Page #					
3" Vanes	2	9	Maximum Width & Length	120"* x 122"	12" x 122"	120"* x 122"	140" x 122"

				Motorization	Motorization	Motorization	Two-On-One
				Bluetooth 7.4V Rechargeable Simplicity	12V Non-Rechargeable Simplicity	7.4V Rechargeable PowerTouch	
More Information On Page				Page 23	Page 21	Page 19	Page 14

* Maximum width of 120" IB, 119¾" OB

	Minimum Width	Hardware
TWO-ON-ONE HARDWARE+	24"	Cord Loop
	24"	Retractable Cord
	NA	Cordless
	28"	Simplicity Motorization
	38"	Simplicity Rechargeable
	36"	PowerTouch Rechargeable

Color Lux® Sheer Shadings
HARDWARE UPGRADE OPTIONS

LIFT SYSTEM	UPGRADES	ADD
Cord Loop	Bottom Up	Included
Retractable Cord	Bottom Up	\$106
Cordless Shading	Bottom Up	\$106

DESIGNER UPGRADE OPTIONS	UPGRADES	ADD
Add to Any Lift System Upgrade (Chart to the left)	Metallic Hardware	\$143
	Scotchgard Stain Protection	\$56
	Highlights Valance <i>See Page 108 For More Information</i>	

ADDITIONAL OPTIONS	UPGRADES	ADD
Add to Any Upgrade Above	Two-On-One Head Rail	Price as two shadings and add together.
Accessories	3 Foot Expandable Pole - Silver	\$35
	5-10 Foot Expandable Pole - Black	\$65

Shangri-La Sheer Horizontal Shadings Motorized Hardware Upgrade Options

MOTORIZED	UPGRADES	ADD	
Simplicity Bluetooth Motorization  Bluetooth	Bluetooth Motors work with Remote Control	\$509	For More Information Page 18
	Color Lux Bluetooth Mobile App	FREE	
7.4V Rechargeable PowerTouch Wand System	Rechargeable Integrated Battery Pack	\$188	For More Information Page 19
	Plug-In Charger for Rechargeable Li-Ion	\$44	
7.4V Rechargeable Simplicity Accessories	Plug-In Charger for Rechargeable Li-Ion	\$44	For More Information Page 23
	7.4v Solar Panel Kit (Remote Control only)	\$168	
7.4V EZ Charge Extension Wand	Wall Mount Receiver Kit	\$33	For More Information Page 26
	Extendable Wand	\$59	
12V Non-Rechargeable Simplicity Motorization System	Motor and Alkaline Battery Wand	\$509	For More Information Page 21 and 27
	48" Extension Wire	\$29	
	Single Unit DC Power Supply/Transformer	\$118	
	9 Channel Wall Mount Low Voltage Hardwire Transformer (More info page 27)	\$420	
Simplicity Systems Controllers	NEO Controller	\$536	For More Information Pages 28, 80 & 22
	NEO Application for Mobile Devices	FREE	
	Simplicity 5 Channel Remote	\$65	
	Simplicity 6 Channel Remote with Timer	\$107	
	Simplicity 14 Channel White Remote	\$107	

Color Lux Shangri-La Sheer Horizontal Sheer Shading Pricing Examples

Two-On-One Pricing Example:

3" Light Filtering	
42" x 60" Shadings:	\$1263.00 x 2
	\$2526.00
Retractable Cord Upgrade:	\$106.00 x 2
	\$212.00
Total List Price:	\$2950.00

Simplicity Rechargeable Motorization Pricing Example:

3" Light Filtering 42" x 60" Shade:	\$1263.00
Metallic Hardware Option	\$143
Simplicity Rechargeable Surcharge:	\$509.00
Charger for Rechargeable (required):	\$44.00
Simplicity Remote Control:	\$65.00
Total List Price:	\$2024.00

Color Lux® Sheer Shadings
PRICING

COLOR LUX SHEER SHADINGS

3" Light Filtering Vanes

PRICE GROUP 1
Cord Loop

		Width In Inches												
		24	30	36	42	48	54	60	66	72	84	96	108	120
Length In Inches	36	729	818	915	1000	1094	1190	1278	1371	1604	1801	1988	2412	2839
	42	768	866	961	1069	1167	1276	1371	1470	1714	1926	2124	2590	3055
	48	813	917	1028	1131	1241	1351	1467	1583	1828	2047	2266	2774	3279
	54	847	960	1081	1198	1321	1436	1566	1696	1937	2169	2425	3037	3646
	60	886	1016	1137	1263	1388	1530	1662	1802	2039	2307	2586	3245	3904
	66	925	1062	1196	1331	1470	1619	1774	1918	2151	2453	2750	3450	4149
	72	961	1110	1255	1399	1553	1714	1870	2031	2266	2590	2910	3676	4437
	78	991	1150	1299	1460	1624	1791	1954	2125	2375	2723	3055	3861	4664
	84	1032	1196	1354	1536	1706	1883	2066	2243	2497	2869	3221	4054	4894
	90	1076	1241	1416	1602	1789	1986	2162	2353	2618	3005	3381	4279	5175
	96	1116	1294	1473	1674	1870	2067	2261	2458	2739	3144	3542	4494	5443
	102	1279	1479	1684	1903	2104	2295	2565	2815	3009	3424	3818	4618	5560
	108	1346	1556	1774	2003	2208	2421	2696	2965	3172	3597	4020	4863	5703
	114	1427	1651	1880	2124	2353	2572	2861	3143	3363	3818	4261	5158	6055
120	1536	1767	2019	2275	2510	2750	3057	3363	3598	4088	4562	5520	6473	
126	1634	1883	2150	2422	2678	2930	3259	3591	3837	4360	4864	5883	6908	
132	1741	2005	2289	2580	2852	3128	3474	3826	4090	4644	5182	6271	7360	

3" Room Darkening Vanes

PRICE GROUP 2
Cord Loop

		Width In Inches												
		24	30	36	42	48	54	60	66	72	84	96	108	120
Length In Inches	36	802	901	1007	1100	1205	1310	1405	1509	1765	1981	2187	2654	3123
	42	845	952	1058	1176	1285	1403	1509	1618	1886	2118	2338	2849	3361
	48	895	1009	1131	1245	1365	1487	1615	1741	2011	2252	2493	3052	3608
	54	933	1057	1189	1319	1454	1581	1723	1866	2131	2386	2668	3341	4010
	60	975	1118	1251	1390	1527	1684	1829	1982	2243	2537	2844	3569	4295
	66	1018	1170	1317	1465	1618	1781	1952	2111	2366	2699	3025	3795	4564
	72	1058	1221	1381	1539	1708	1886	2057	2235	2493	2849	3202	4043	4881
	78	1091	1265	1430	1606	1787	1970	2150	2339	2613	2996	3361	4247	5131
	84	1136	1317	1490	1691	1877	2072	2273	2467	2748	3156	3544	4459	5384
	90	1184	1365	1558	1763	1968	2185	2379	2589	2880	3306	3720	4708	5693
	96	1228	1424	1621	1842	2057	2274	2488	2704	3013	3459	3896	4944	5988
	102	1407	1627	1852	2093	2315	2525	2822	3098	3311	3767	4200	5080	6117
	108	1481	1711	1952	2204	2429	2663	2966	3261	3489	3958	4422	5350	6273
	114	1570	1816	2069	2338	2589	2830	3147	3458	3700	4200	4687	5674	6660
120	1691	1944	2221	2502	2761	3025	3362	3700	3959	4496	5019	6072	7121	
122	1798	2072	2365	2665	2946	3223	3586	3951	4221	4797	5351	6472	7599	

LIFT SYSTEM	UPGRADES	ADD
Cord Loop	Bottom Up	Included
Retractable Cord	Bottom Up	\$106
Cordless Shading	Bottom Up	\$106

DESIGNER UPGRADE OPTIONS	UPGRADES	ADD
Add to Any Lift System Upgrade (Chart to the left)	Metallic Hardware	\$143
	Scotchgard Stain Protection	\$56
	Highlights Valance <i>See Page 108 For More Information</i>	

ADDITIONAL OPTIONS	UPGRADES	ADD
Add to Any Upgrade Above	Two-On-One Head Rail	Price as two shadings and add together.
Accessories	3 Foot Expandable Pole - Silver	\$35
	5-10 Foot Expandable Pole - Black	\$65

MOTORIZATION	MORE INFO
For motorization surcharges and options refer to page 7.	Pg 7

Shadings wider than 96": Shadings over 96" in width may require additional fabrication and delivery time.

Color Lux® Sheer Shadings
PRICING

3" Light Filtering Vanes

White-on-White Color Lux Prints Only

PRICE GROUP 3
DoorStyles*

		Width In Inches											
		6	12	18	24	30	36	42	48	54	60	66	72
Length In Inches	12	622	635	654	667	744	837	899	917	1017	1037	1059	1256
	18	623	643	660	679	763	858	929	949	1054	1083	1105	1323
	24	626	651	669	694	778	883	954	981	1097	1124	1154	1382
	30	631	656	682	705	794	902	984	1014	1138	1171	1199	1441
	36	634	660	692	734	821	920	1004	1100	1195	1284	1379	1615
	42	679	713	745	771	870	967	1073	1174	1281	1379	1479	1722
	48	700	740	842	818	922	1034	1138	1247	1359	1473	1590	1835
	54	717	760	804	850	966	1085	1205	1326	1446	1572	1705	1949
	60	741	786	832	889	1020	1143	1268	1396	1537	1670	1812	2050
	66	782	832	887	929	1069	1200	1336	1479	1626	1783	1926	2161
	72	804	861	920	967	1116	1261	1404	1560	1722	1880	2039	2278
	78	821	888	949	995	1154	1306						
	84	850	917	984	1037	1200	1362						
90	873	947	1019	1082	1247	1422							
96	899	977	1053	1120	1299	1483							

3" Room Darkening Vanes

White-on-White Color Lux Prints Only

PRICE GROUP 4
DoorStyles*

		Width In Inches											
		6	12	18	24	30	36	42	48	54	60	66	72
Length In Inches	12	684	699	719	734	819	921	989	1009	1119	1141	1165	1382
	18	685	708	726	747	839	945	1022	1045	1160	1192	1216	1456
	24	689	717	736	764	856	972	1050	1080	1208	1238	1269	1521
	30	695	721	751	776	873	992	1083	1116	1252	1288	1320	1586
	36	698	726	762	808	904	1013	1105	1210	1315	1413	1517	1776
	42	747	785	820	848	957	1063	1181	1291	1410	1517	1627	1895
	48	770	814	926	901	1015	1138	1252	1371	1495	1621	1749	2019
	54	789	836	884	936	1062	1194	1325	1459	1591	1730	1876	2145
	60	815	866	915	979	1122	1257	1396	1536	1692	1838	1994	2255
	66	861	915	977	1022	1176	1321	1470	1627	1789	1963	2118	2378
	72	884	947	1013	1063	1228	1388	1545	1716	1895	2069	2243	2506
	78	904	978	1045	1095	1269	1436						
	84	936	1009	1083	1141	1321	1499						
90	960	1042	1121	1190	1371	1564							
96	989	1075	1159	1232	1430	1631							

ADDITIONAL OPTIONS

Scotchgard Stain Protection	\$56
3 Foot Expandable Pole - Silver	\$35
5-10 Foot Expandable Pole - Black	\$65

*Rails and endcaps on Shangri-La DoorStyles Shadings are coordinated to the fabric color.
Hardware used on DoorStyles may not match standard shadings.



Fabric Wrapped

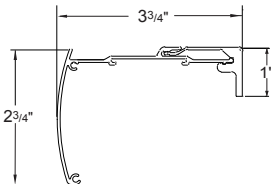

Fabric Wrapped Designer Cassette Head Rail

- Depth of rail and bracket: 3 3/4"
- Height of rail: 2 3/4"
- Height of bracket: 1"



Bottom Rail Partly Opened



Bottom Rail Closed

(Bottom Rail is always fabric wrapped)

Hardware Features

Standard Designer Cassette	Fabric Wrapped Designer Cassette is standard. Head rail endcap is fabric covered
Bottom Rail Color	Bottom rail is fabric wrapped with white end caps.

Head Rail Upgrades (Bottom rail is always fabric wrapped)

Designer Metallic Upgrade (Smooth Face)	<ul style="list-style-type: none"> • Oil Rubbed Bronze • Onyx Black • Brushed Nickel
---	---

Mounting Dimensions	Designer Cassette Head Rail
Minimum Shallow Mount	1"
Minimum Flush Inside Mount (including brackets)	3 3/4"
Minimum Outside Mount	1"
Minimum Side Mount	1 1/4"
Width Side Mount	48" Max width side mount

Finished Dimensions

Mounting Type	Dimensions
Inside Mount	<ul style="list-style-type: none"> • Fabric will measure ordered width less: 1" • Head rail* will measure ordered width less: 3/16"
Side (End) Mount	<ul style="list-style-type: none"> • Fabric will measure ordered width less: 1 1/2" • Head rail* will measure ordered width less: 1 1/16"
Outside Mount	<ul style="list-style-type: none"> • Fabric will measure ordered width less: 5/8" • Head rail* will measure ordered width plus: 3/16"
Exact (End Cap to End Cap) Mount	<ul style="list-style-type: none"> • Fabric will measure ordered width less: 13/16" • Head rail* will measure ordered width

* Head rail measurements include endcaps. Width and length measurements may vary +/- 1/8"

Please Note: Once ordered and manufactured, the width of the Shangri-La fabric cannot be altered. Comfortex makes deductions to the width depending on the type of mounting indicated. For all mounting types, fabric will measure exactly the length ordered when the vanes are in the opened position.

Color Lux® Sheer Shadings

CORD LOOP SHADING HARDWARE SYSTEM | DESIGNER CASSETTE HEAD RAIL

Head Rail Options

Fabric Wrapped Designer Cassette Head Rail is standard. End caps of the head rail are fabric covered.

Designer Metallic Upgrade is available. Colors available: Oil Rubbed Bronze, Onyx Black and Brushed Nickel. Bottom rail is always fabric wrapped.

Cord Type and Color

White, black or bronze loop cord coordinates with your hardware choice. Bead cord is optional in white, bronze, black or steel. Cord tensioners match your hardware choice (white, black or bronze). Lengths over 6 feet available in white only.

Reverse Roll

The braided cord does not have a reverse roll stop. If a shading with the Designer Cassette hardware is raised above 24" in the reverse roll mode, there is a possibility of the fabric rubbing on the head rail. Comfortex reserves the right NOT to warrant wear and tear of fabric if damaged by roll-up in excess of 24".

Length Considerations with Shangri-La Shadings

Comfortex will fabricate your Shangri-La Window Shading to the length ordered, when the vanes are in the open position (Figure A).

- When the vanes are rotated to the closed position, the shading will become slightly longer.
- When closed on an inside mount, the shading will be slightly longer than ordered length.
- Rotating the vanes closed will cause the bottom rail to touch the window sill, before it begins to raise.

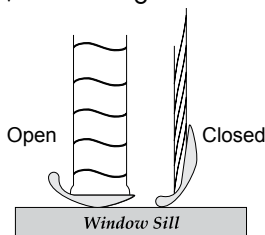

Figure A

Side By Side Alignment

When Shangri-La Window Shadings are installed side-by-side, vane alignment can be guaranteed within 1/4" only if:

- The shadings are the same color and ordered at the same time.
- The sum total of the widths of all shadings needing alignment is less than 118".

Side-by-side lineup is specified when the order is placed.

Omni-View System

Shangri-La Shadings feature the Omni-View™ Cord System. The Omni-View System provides the ability to manipulate the shading into various viewing positions. There are variations in visibility through the shadings when the vanes are tilted to their maximum open positions. The following five modes can be obtained with standard shading operation when viewing the shading at eye level.

- **Closed top, open bottom:** By partially lowering the shading from the fully raised position, the upper portion of your window will become semi-opaque while allowing a clear view below.
- **Fully private:** When lowered completely, Shangri-La provides complete privacy and softly diffused light.
- **Partially open:** Opening Shangri-La slightly will gradually increase the level of light and allow varying levels of view through.
- **View-through when lowered:** By completely opening the vanes, Shangri-La provides a softened, veiled view to the outside.
- **View-through when raised:** From the open or view-through position, continuing to pull down on the back of the cord will raise the fabric allowing a clear view outside from below, and a veiled view above. This exclusive feature allows Shangri-La to be raised up to 24" in this mode.
- Comfortex recommends that you **do not** raise the shading more than 24" off the sill in the view-through when raised mode. Refer to warranty section below for more information.
- Omni-View capability is available with all Shangri-La Shadings except cordless.

Cord Information For Shangri-La Shadings

A braided cord loop is used to raise and lower the shading. White, black or bronze loop cord matches your hardware choice. Cord tensioner will match the hardware color.

Bead cord is available in black, white, bronze, nickel and steel. Lengths over 6 feet available in white only.

The cord loop will measure the length indicated below unless otherwise specified.

Shade Length	Standard Loop
16" to 26 ⁷ / ₈ "	1' (12")
27" to 39 ⁷ / ₈ "	2' (24")
40" to 59 ⁷ / ₈ "	3' (36")
60" to 83 ⁷ / ₈ "	4' (48")
84" to 107 ⁷ / ₈ "	5' (60")
108" and greater	6' (72")

Maximum cord length is 15 feet. Polyester cord can be ordered in custom lengths in 1 foot increments only.

Braided Cord Loop Warranty Information

The shadings built with a braided cord loop do not have a reverse roll stop. If a shading is raised above 24" in the reverse roll mode, there is a possibility of the fabric rubbing on the head rail. Comfortex reserves the right NOT to warrant wear and tear of fabric if damaged by roll-up in excess of 24".

Color Lux® Sheer Shadings

RETRACTABLE CORD HARDWARE SYSTEM | DESIGNER CASSETTE HEAD RAIL



Fabric Wrapped

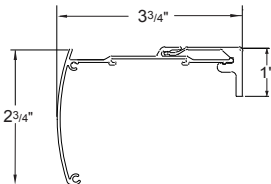

Fabric Wrapped Designer Cassette Head Rail

- Depth of rail and bracket: 3 3/4"
- Height of rail: 2 3/4"
- Height of bracket: 1"

Hardware Features	
Standard Designer Cassette	Fabric Wrapped Designer Cassette is standard. Head rail endcap is fabric covered
Bottom Rail Color	Bottom rail is fabric wrapped with white end caps.
Head Rail Upgrades <i>(Bottom rail is always fabric wrapped)</i>	
Designer Metallic Upgrade (Smooth Face)	<ul style="list-style-type: none"> • Oil Rubbed Bronze • Onyx Black • Brushed Nickel
Mounting Dimensions	Mounting and Finished Dimensions are the same as Cord Loop See Page 10
Finished Dimensions	

Retractable Cord Shadings

The Retractable Cord option is a single cord design that provides easy one hand operation to raise, lower and open and close the vanes.

- Retractable Cord hardware is an alternative to conventional cord loop controls. The short retractable cord maintains a consistent length whether the shadings are raised or lowered. The elimination of cord loop enhances child and pet safety.
- Available with all fabrics with Designer Cassette.
- White, black or bronze cord and tassel coordinates your hardware color choice.
- Standard cord length is 40% the length of the shading. Cord may be shortened to match consumer operating preferences and to keep out of reach of children. Cord length can be easily modified in the field.
- Mounting a cord tensioner is not necessary. Cord cleat is recommended.

Overall Operation

When raising and lowering the shading, pull the cord down in long, even strokes. Allow the cord to fully retract into the head rail after each downward stroke.

To Lower The Shading And Open The Vanes

- Pull the cord down toward the center of the shading with long strokes. Continue until the shading is fully lowered and the vanes are open.
- Allow the cord to retract completely into the head rail after each downward stroke.
- The shading can be stopped at any point while lowering

To Tilt The Vanes And Raise Shading

- Pull the cord straight down or down and slightly out with long strokes. With each stroke the shading partially raises.
- Allow the cord to retract completely into the head rail after each downward stroke.
- Use multiple strokes until the shading reaches the desired position.
- The shading can be stopped at any point while raising.

Color Lux® Sheer Shadings

TWO-ON-ONE HARDWARE SYSTEM | DESIGNER CASSETTE HEAD RAIL



Fabric Wrapped

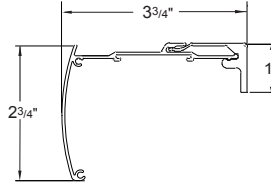

Fabric Wrapped Designer Cassette Head Rail

- Depth of rail and bracket: 3 3/4"
- Height of rail: 2 3/4"
- Height of bracket: 1"

Hardware Features	
Standard Designer Cassette	Fabric Wrapped Designer Cassette is standard. Head rail endcap is fabric covered
Bottom Rail Color	Bottom rail is fabric wrapped with white end caps.
Head Rail Upgrades <i>(Bottom rail is always fabric wrapped)</i>	
Designer Metallic Upgrade (Smooth Face)	<ul style="list-style-type: none"> • Oil Rubbed Bronze • Onyx Black • Brushed Nickel
Mounting Dimensions	Mounting and Finished Dimensions are the same as Cord Loop See Page 10
Finished Dimensions	

Two-On-One Designer Cassette Head Rail

Two-On-One Head Rail shadings are two shadings sharing the same head rail; each shading operates independently.

- Two-On-One Head Rail can be combined with cord loop, PowerTouch Rechargeable, Simplicity Motorization and retractable cord hardware options. Price as two shadings (including upgrades) and add together. Pricing example on page 8.
- Two-On-One not available with cordless.
- Specify shading total width and two individual section widths. **Note:** The two individual sections must add up to the total width.
- Two on One Head Rail Shadings are available with bead cord or braided cord loop. See page 12 for more information.

- Controls will always be placed to the far left and far right.
- Available in widths up to 140" with Designer Cassette hardware.
- Minimum single section width is 12". Maximum single section width is 102". The center gap between shadings is 3/8".
- Side by side alignment is available if the two panels measure less than 120". Alignment must be specified when the order is placed.
- Shadings over 98" are subject to common carrier surcharge. See page 112 for more information on the freight policy.

Color Lux® Sheer Shadings
CORDLESS HARDWARE SYSTEM | DESIGNER CASSETTE HEAD RAIL

COLOR LUX SHEER SHADINGS



Fabric Wrapped

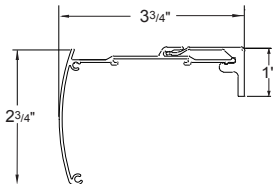

Fabric Wrapped Designer Cassette Head Rail

- Depth of rail and bracket: 3 3/4"
- Height of rail: 2 3/4"
- Height of bracket: 1"

Hardware Features	
Standard Designer Cassette	Fabric Wrapped Designer Cassette is standard. Head rail endcap is fabric covered
Bottom Rail Color	Bottom rail is fabric wrapped with white end caps and inner end caps. Handle is clear
Upgrades	
Designer Metallic Upgrade (Smooth Face)	<ul style="list-style-type: none"> • Oil Rubbed Bronze • Onyx Black • Brushed Nickel
Mounting Dimensions	
Designer Cassette Head Rail	
Minimum Shallow Mount	1"
Minimum Flush Inside Mount (including brackets)	3 3/4"
Minimum Outside Mount	1"
Minimum Side Mount	1 1/4"
Maximum Side Mount	48"
Finished Dimensions	
Inside Mount	
	<ul style="list-style-type: none"> • Fabric will measure ordered width less: 7/8" • Head rail* will measure ordered width less: 3/16"
Side (End) Mount	
	<ul style="list-style-type: none"> • Fabric will measure ordered width less: 1 3/8" • Head rail* will measure ordered width less: 1 1/16"
Outside Mount	
	<ul style="list-style-type: none"> • Fabric will measure ordered width less: 1/2" • Head rail* will measure ordered width plus: 3/16"
Exact (End Cap to End Cap) Mount	
	<ul style="list-style-type: none"> • Fabric will measure ordered width less: 1 1/16" • Head rail* will measure ordered width
* Head rail measurements include endcaps. Width and length measurements may vary +/- 1/8"	

Please Note: Once ordered and manufactured, the width of the Shangri-La fabric cannot be altered. Comfortex makes deductions to the width depending on the type of mounting indicated. For all mounting types, fabric will measure exactly the length ordered when the vanes are in the closed position.

Color Lux® Sheer Shadings

CORDLESS HARDWARE SYSTEM | DESIGNER CASSETTE HEAD RAIL

Cordless Shangri-La Shadings Head Rail

- The Standard Designer Cassette head rail is fabric wrapped.
- Designer Cassette head rail is also available in Oil Rubbed Bronze, Brushed Nickel and Onyx Black.
- Shangri-La Cordless Sheer Horizontal Shadings use quick-snap, no-light-gap brackets.

Cordless Shangri-La Shadings Bottom Rail

- Bottom rail includes a sliding weight to adjust fabric skewing if necessary.
Bottom rail is always fabric wrapped.

Operating A Cordless Shangri-La Shading

Cordless Shangri-La Shadings utilize a roller catch mechanism in the head rail which allows for the vanes to be adjusted into various positions.

Pull the handle that is attached to the bottom rail until the shading reaches the desired length, allow catch mechanism to engage and lock shade in desired position.

To Open Or Close Vanes

Lower the shading all the way down and continue pulling down on the handle until the vanes open. The roller catch mechanism allows the vanes to be adjusted open, closed and to various positions in between.

When adjusting the vane position, release the catch by tugging on the handle, roll up the shading several inches (this resets the catch mechanism), then pull back down to the desired position.

- The Omni-View setting is not available with Shangri-La Cordless Shadings.

To Raise The Shading

Pull down on the handle to release the catch mechanism and let the shading rise. Tug the handle to lock the shade in the desired position.

When first learning to operate the shading, it may take a few tries to get the feel of the mechanism.



Cordless Handle



Cordless Handle Being Pulled Down

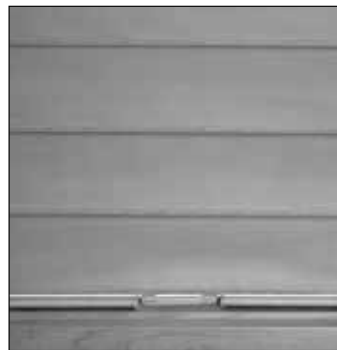

Cordless Handle on Window Sill

Color Lux® Sheer Shadings
SHANGRI-LA DOORSTYLES HARDWARE SYSTEM

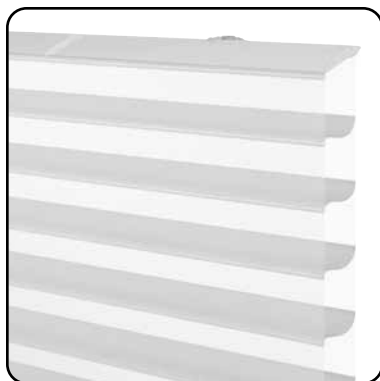

White-on-White Color Lux Prints Only

Hardware Features	
Standard Hardware	Hardware used on DoorStyles Shadings may not match standard shadings.
Bottom Rail Color	Rails and end caps on Shangri-la DoorStyles Shadings are coordinated to the fabric color. With Brushed Nickel Head rail, bottom rail will be coordinated to fabric.
Upgrades	
Designer Metallic Upgrade	Not Available
Hinges & Handle	Polished Brass
Mounting Dimensions	
	DoorStyles Hardware
Minimum Shallow Mount	1½"
Minimum Flush Inside Mount (including brackets)	2⅝"
Minimum Outside Mount	¾"
Finished Dimensions	
Inside Mount	
	<ul style="list-style-type: none"> • Fabric will measure ordered width less: ⅝" • Head rail* will measure ordered width less: ⅜"
Outside Mount	
	<ul style="list-style-type: none"> • Fabric will measure ordered width • Head rail* will measure ordered width plus: ⅜"
Exact (End Cap to End Cap) Mount	
	<ul style="list-style-type: none"> • Fabric will measure ordered width less: ⅜" • Head rail* will measure ordered width
* Head rail measurements include endcaps. Width and length measurements may vary +/- ⅛" Side Mount is not available for DoorStyles	

Please Note: Once ordered and manufactured, the width of the Shangri-La fabric cannot be altered. Comfortex makes deductions to the width depending on the type of mounting indicated.

Color Lux® Sheer Shadings

SHANGRI-LA DOORSTYLES HARDWARE SYSTEM

Shangri-La DoorStyles Shadings

Shangri-La DoorStyles Shadings cover French doors, transoms and sidelights for a look of sheer perfection without a bulky head rail. They attach to the window frame or door with unobtrusive hinges and tilt open and closed with easy to install hardware. An operating handle allows the fabric to be tilted open and closed (Figure A).

Hardware used on DoorStyle Shadings may not match standard shadings.

Fabric

All 3" light filtering and room darkening fabric collections are available as DoorStyle Window Shadings.

Rails and end caps on Shangri-La DoorStyles Shadings are coordinated to the fabric color.

Designer Metallic Hardware Upgrade: Not available with DoorStyles.

Operating Pole

An operating pole is available for hard to reach windows and doors. Please specify when ordering.

3 Foot Expandable Pole

5-10 Foot Expandable Pole

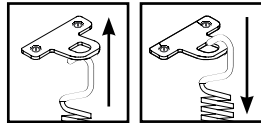

DoorStyles Shading Specifications

Minimum Width: 6" Maximum Width: 72"

Minimum Length: 12" Maximum Length: 72"*

*Maximum length varies by width.

DoorStyles are **not** available with 2½" vane fabrics.

Please Note: Once ordered and manufactured, the width of the Shangri-La fabric cannot be altered. Comfortex makes deductions to the width depending on the type of mounting indicated. For all mounting types, fabric will measure exactly the length ordered when the vanes are in the open or "view-through" position.

Length Considerations With Shangri-La DoorStyles

Comfortex will fabricate your Shangri-La DoorStyles to the length ordered when the vanes are in the open (or view through) position. When the vanes are tilted to the closed position, the shading will become 1¾" longer.

When closed on an inside mount or when used with hold down brackets, a slight puckering may occur.

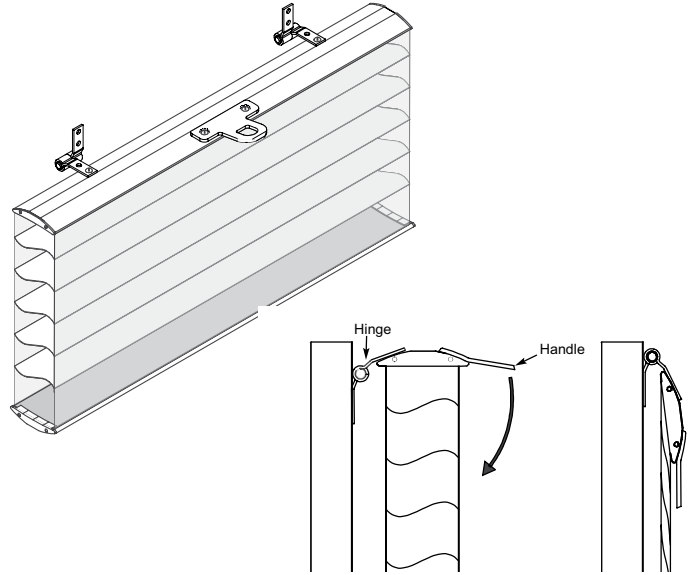
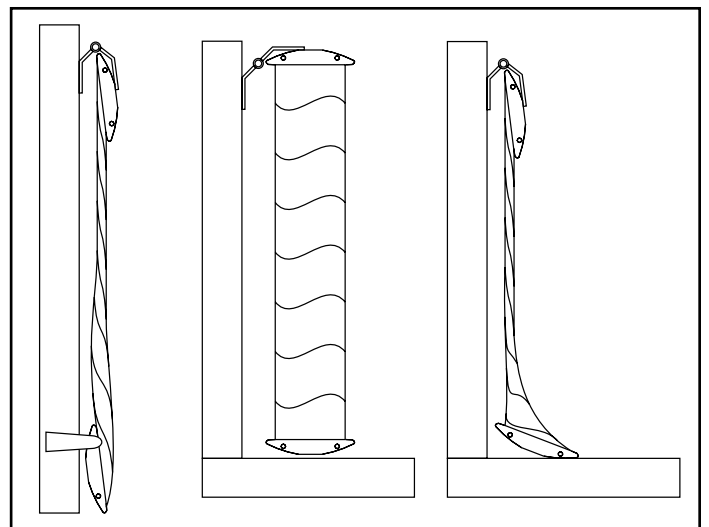

Figure A



Color Lux® Sheer Shadings
SIMPLICITY BLUETOOTH MOTORIZATION

COLOR LUX SHEER SHADINGS



PRODUCT	Simplicity PowerTouch	Simplicity Remote	NEO Smart Controller	Simplicity w/ Bluetooth	Rechargeable SOMFY	12v Low Volt Hardwire
Cellular	•	•	•			•
Color Lux Cellular	•		•	•		•
Cellular Top-Down Bottom-Up		•	•			
Color Lux Cellular Top-Down Bottom-Up			•	•		
Mezzo Skylight			•	•		
Mezzo Skylight			•	•		
Odyssey	•	•	•			
Shangri-La Sheer Shadings	•	•	•			•
Color Lux Sheer Shadings	•		•	•		•
Overtones	•	•	•			
Elevance Roman			•	•		•
Roller - Color Lux and Envision	•		•	•		•
Soft Roman	•		•	•		
Roller Pro					•	
Wood & Faux - Newport & Aria					•	

Benefits of Simplicity BlueTooth™ Motorization: Featuring the Free Color Lux Mobile App

- New “state of the art” 7.4v rechargeable motorization operates with both BlueTooth and Radio Frequency control technology.
- Download the new Color Lux Mobile Bluetooth App FREE on the Apple App Store for iPhone or the Google Play Store for Android.
- Optional Simplicity radio frequency remote control with choice of 5 channel, 6 channel with timer, or 14 channel remote.
- Optional Simplicity Smart Controller (NEO) for remote operation of shades which integrates with Amazon Alexa and Google Assistant devices.

Features of the Color Lux Mobile Bluetooth App:

- Controls your shade directly from your phone with Bluetooth control.
- Has a shade position display indicator. See screen to the right.
- Has a battery charge level indicator.
- Controls the shade using easy swipe or control buttons.
- Controls up to 5 shades simultaneously and no limit to the number of shades connected to a single account.
- Has timer and scene setting options.

Please Note: There are many factors affecting Bluetooth range

- Physical obstacles in the transmission path
- The antennas should be exposed for best performance
- Bluetooth 4.2 supports 10 meters indoor range (~33 feet).



Color Lux Mobile App Main Screen

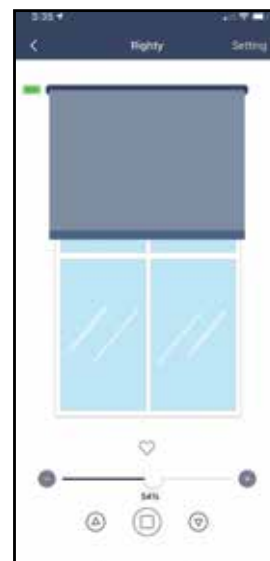

Color Lux Mobile App Control Screen

Color Lux® Sheer Shadings

7.4V RECHARGEABLE POWERTOUCHE HARDWARE SYSTEM | DESIGNER CASSETTE HEAD RAIL



Fabric Wrapped

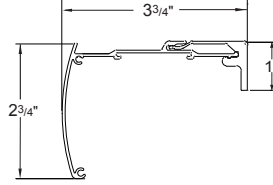

Fabric Wrapped Designer Cassette Head Rail

- Depth of rail and bracket: 3 3/4"
- Height of rail: 2 3/4"
- Height of bracket: 1"

Hardware Features	
Standard Designer Cassette	Fabric Wrapped Designer Cassette is standard. Head rail endcap is fabric covered
Bottom Rail Color	Bottom rail is fabric wrapped with white end caps.
Head Rail Upgrades <i>(Bottom rail is always fabric wrapped)</i>	
Designer Metallic Upgrade (Smooth Face)	<ul style="list-style-type: none"> • Oil Rubbed Bronze • Onyx Black • Brushed Nickel
Mounting Dimensions	
Designer Cassette Head Rail	
Minimum Shallow Mount	1"
Minimum Flush Inside Mount (including brackets)	3 3/4"
Minimum Outside Mount	1"
Minimum Side Mount	1 1/4"
Width Side Mount	48" Max width side mount
Finished Dimensions	
Inside Mount	
	<ul style="list-style-type: none"> • Fabric will measure ordered width less: 1" • Head rail* will measure ordered width less: 3/16"
Side (End) Mount	
	<ul style="list-style-type: none"> • Fabric will measure ordered width less: 1 1/2" • Head rail* will measure ordered width less: 1 1/16"
Outside Mount	
	<ul style="list-style-type: none"> • Fabric will measure ordered width less: 5/8" • Head rail* will measure ordered width plus: 3/16"
Exact (End Cap to End Cap) Mount	
	<ul style="list-style-type: none"> • Fabric will measure ordered width less: 1 3/16" • Head rail* will measure ordered width
* Head rail measurements include endcaps. Width and length measurements may vary +/- 1/8"	

Please Note: Once ordered and manufactured, the width of the Shangri-La fabric cannot be altered. Comfortex makes deductions to the width depending on the type of mounting indicated. For all mounting types, fabric will measure exactly the length ordered when the vanes are in the open position.

Color Lux® Sheer Shadings

7.4V RECHARGEABLE POWERTOCH HARDWARE SYSTEM | DESIGNER CASSETTE HEAD RAIL

COLOR LUX SHEER SHADINGS

PowerTouch™ Rechargeable Shades

Sheer Shadings can be fabricated with the PowerTouch Rechargeable Push Button Control option. The PowerTouch Rechargeable option is an easy, cord free motorized operation for the budget savvy homeowner. PowerTouch Rechargeable uses Simplicity motors and components.

PowerTouch Rechargeable Shades Operation

Press the up or down button on the pendant to raise or lower the shading to your desired position. When the shading is fully lowered to the factory programmed lower limit, the bottom rail will be set in the level position.

No programming is required with PowerTouch™, all programming is set at the factory. Upper and lower limits easily can be adjusted in the field if desired. Please refer to the installation instructions at comfortex.com/comfortex-dealers. Favorites position can be programmed on-site.

PowerTouch Rechargeable Surcharges

See page 8.

PowerTouch Appearance

- The PowerTouch Rechargeable wand and pendant is attached to the head rail and requires no additional mounting.
- The wand and pendant hangs down the front of the shades from the head rail. The wand does not touch the fabric.
- Pendant is 2½" long.
- The pendant does not need to be mounted to the wall to operate the shade.



PowerTouch Rechargeable Color Options

- Shadings with Black or Oil Rubbed Bronze hardware will be built with black wand and pendants standard. All other colors will use white wand and pendants.



White



Black Shown with Plug-In Charger

PowerTouch Wand and Pendant Location

The standard location for the wand and pendant is on the right. Please specify location when ordering.

PowerTouch Rechargeable Wand Length

The standard length of the wand will measure the indicated below unless otherwise specified.

Shading Length	Standard Wand Length
Up to 30"	1' (12")
>30" to 52"	2' (24")
>52" to 78"	3' (36")
>78" to 100"	4' (48")
>100" to 120"	5' (60")

- Wand length is in 1 foot increments. 1 foot - 5 foot

Mounting Requirements for PowerTouch Rechargeable Shadings

- No special installation hardware or wiring requirements are needed.
- The wand and pendant do not need to be mounted to operate the shading.

Integrated Rechargeable Motor Battery Life

Rechargeable battery is included with the motor.

The average battery charge will last 6-12 months based on an average sized shade raised and lowered once per day. The life of the battery charge will vary based on the type of window covering selected, the size and weight of the window covering and the number of times the shade is operated on a daily basis.

The battery can be recharged up to 500 times. It takes approximately 5 hours to recharge the motor when fully depleted.

Battery Charger

8.4 Volt charger requires a standard power outlet to recharge the battery. Must specify charger when ordering a Simplicity PowerTouch Rechargeable Shading. The charger plugs into the charger port. The charger is black and comes with a 156" wire. The dimensions are 1" wide x 2½" length x 1¾" deep.



PowerTouch Rechargeable Shadings Warranty

Please see page 114 for complete warranty information.

Color Lux® Sheer Shadings

12V NON-RECHARGEABLE SIMPLICITY MOTORIZATION | DESIGNER CASSETTE HEAD RAIL



Fabric Wrapped

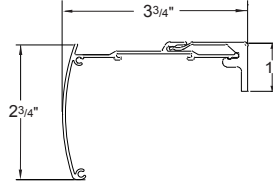

Smooth Face Designer Cassette Head Rail

- Depth of rail and bracket: 3 3/4"
- Height of rail: 2 3/4"
- Height of bracket: 1"

Hardware Features	
Standard Designer Cassette	Fabric Wrapped Designer Cassette is standard. Head rail endcap is fabric covered
Bottom Rail Color	Bottom rail is fabric wrapped with white end caps.
Head Rail Upgrades <i>(Bottom rail is always fabric wrapped)</i>	
Designer Metallic Upgrade (Smooth Face)	<ul style="list-style-type: none"> • Oil Rubbed Bronze • Onyx Black • Brushed Nickel
Mounting Dimensions	
Designer Cassette Head Rail	
Minimum Shallow Mount	1"
Minimum Flush Inside Mount (including brackets)	3 3/4"
Minimum Outside Mount	1"
Minimum Side Mount	1 1/4"
Width Side Mount	48" Max width side mount
Finished Dimensions	
Inside Mount	
	<ul style="list-style-type: none"> • Fabric will measure ordered width less: 1" • Head rail* will measure ordered width less: 3/16"
Side (End) Mount	
	<ul style="list-style-type: none"> • Fabric will measure ordered width less: 1 1/2" • Head rail* will measure ordered width less: 1 1/16"
Outside Mount	
	<ul style="list-style-type: none"> • Fabric will measure ordered width less: 5/8" • Head rail* will measure ordered width plus: 3/16"
Exact (End Cap to End Cap) Mount	
	<ul style="list-style-type: none"> • Fabric will measure ordered width less: 1 3/16" • Head rail* will measure ordered width
* Head rail measurements include endcaps. Width and length measurements may vary +/- 1/8"	

Please Note: Once ordered and manufactured, the width of the Shangri-La fabric cannot be altered. Comfortex makes deductions to the width depending on the type of mounting indicated. For all mounting types, fabric will measure exactly the length ordered when the vanes are in the open position.

Color Lux® Sheer Shadings

12V NON-RECHARGEABLE SIMPLICITY MOTORIZATION | DESIGNER CASSETTE HEAD RAIL

COLOR LUX SHEER SHADINGS

Non-Rechargeable Simplicity Motors

The non-rechargeable Simplicity Motor program features a battery powered motor utilizing a single battery wand that contains disposable AA batteries or plug-in DC transformer. Simplicity motors are compact and use a radio frequency remote to raise or lower the shadings. The Simplicity motor is concealed in the head rail.

See page 23 for information on Simplicity Rechargeable system version.

Simplicity Motors With Designer Cassette

No special installation hardware or wiring requirements are needed to install motorized Shangri-La Shadings with Designer Cassette Head Rail. See page 21 for mounting information.

Simplicity Battery Wand

The battery wand can be clipped to the Designer Cassette head rail. Can not be mounted on shadings under 25" wide. The battery wand is wall or ceiling mounted utilizing white battery wand clips. The 12 volt battery wand measures 17¼", and comes with eight alkaline batteries, and is white in color. The battery wand must be placed so it does not interfere with the mounting brackets.

The battery wire is 10" long. A 48" extension wire is available.



Simplicity Motor Battery Life and Replacement

Eight alkaline batteries are included with the wand. The battery life will vary based on the type of window covering selected, the size and weight of the window covering and the number of times you operate the shade on a daily basis.

Comfortex will warranty batteries for up to 3 months from date of purchase. Batteries are not covered by the warranty.

DC Power Supply/Transformer

12 Volt DC power supply/transformer is available and requires a standard power outlet to power the motor. The transformer is an alternative to a battery wand. Each transformer can power a single shading. The power supply must plug in to the motor. The DC power supply is white and comes with a 80" wire. The dimensions are 1⅞" wide x 3¼" long x 1¼" deep. Extension wires are available if needed.



Important Simplicity Motorized Shading Operating and Installation Information

Simplicity Motorized Shadings installed into windows with metal casings may have a reduced radio frequency range, or may not operate at all, depending on the application

Simplicity Motor Hand Held Remotes

IMPORTANT: Simplicity Rechargeable Motorized Shadings are programmed at the factory with the "up and down" limits. The shades are **UNLINKED** from the remote so they are not able to operate during shipping. Each shade should be installed **before** linking it to the remote.

5 Channel Remote

The **5 Channel (5C) remote** can operate up to five shadings simultaneously, individually or in groups.

Simplicity (5C) remotes and holders are black or white in color. The remote comes with a holder which can be mounted to a wall for easy storage. The range of the remote is approximately 80 feet.



6 Channel Timer Remote also available

See page 24 for more information

14 Channel Remote

This remote has 14-channels. Each channel has a setting to operate the bottom rail. The **14 Channel remote** can operate up to fourteen shades individually or 14 groups.

14 Channel remotes and holders are white in color. The remote comes with a holder which can be mounted to a wall for easy storage. The range of the remote is approximately 80 feet.



Please Note:

- Not all motors run at the same rate of speed.
- Simplicity motors have a "Favorites" or "MY" position setting. If the homeowner wants to set several shadings at the same intermediate position, follow instructions provided with installation manual.

Simplicity Battery Operated Motorized Shadings Warranty

Please see page 114 for complete Comfortex warranty information.

NEW Simplicity Bluetooth Motorization

Learn about Simplicity Bluetooth motorization and Comfortex FREE Color Lux Mobile App on page 18.

Color Lux® Sheer Shadings
7.4V RECHARGEABLE SIMPLICITY HARDWARE SYSTEM



COLOR LUX SHEER SHADINGS



Fabric Wrapped

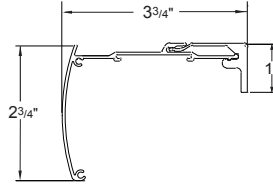

Fabric Wrapped Designer Cassette Head Rail

- Depth of rail and bracket: 3 3/4"
- Height of rail: 2 3/4"
- Height of bracket: 1"

Color Lux 7.4V rechargeable Simplicity features Bluetooth communication.



New "state of the art" 7.4v rechargeable motorization operates with both Bluetooth and Radio Frequency control technology.

Hardware Features	
Standard Designer Cassette	Fabric Wrapped Designer Cassette is standard. Head rail endcap is fabric covered
Bottom Rail Color	Bottom rail is fabric wrapped with white end caps.
Head Rail Upgrades <i>(Bottom rail is always fabric wrapped)</i>	
Designer Metallic Upgrade (Smooth Face)	<ul style="list-style-type: none"> • Oil Rubbed Bronze • Onyx Black • Brushed Nickel
Mounting Dimensions	
Designer Cassette Head Rail	
Minimum Shallow Mount	1"
Minimum Flush Inside Mount (including brackets)	3 3/4"
Minimum Outside Mount	1"
Minimum Side Mount	1 1/4"
Width Side Mount	48" Max width side mount
Finished Dimensions	
Inside Mount	
	<ul style="list-style-type: none"> • Fabric will measure ordered width less: 1" • Head rail* will measure ordered width less: 3/16"
Side (End) Mount	
	<ul style="list-style-type: none"> • Fabric will measure ordered width less: 1 1/2" • Head rail* will measure ordered width less: 1 1/16"
Outside Mount	
	<ul style="list-style-type: none"> • Fabric will measure ordered width less: 5/8" • Head rail* will measure ordered width plus: 3/16"
Exact (End Cap to End Cap) Mount	
	<ul style="list-style-type: none"> • Fabric will measure ordered width less: 1 3/16" • Head rail* will measure ordered width
* Head rail measurements include endcaps. Width and length measurements may vary +/- 1/8"	

Please Note: Once ordered and manufactured, the width of the Shangri-La fabric cannot be altered. Comfortex makes deductions to the width depending on the type of mounting indicated. For all mounting types, fabric will measure exactly the length ordered when the vanes are in the open position.

Color Lux® Sheer Shadings

7.4V RECHARGEABLE SIMPLICITY HARDWARE SYSTEM



Bluetooth Simplicity Rechargeable Motors

The Rechargeable Simplicity Motor program features an integrated rechargeable lithium ion battery in the motor casing and is fully concealed by the roller tube.

PowerTouch Integrated Rechargeable Surcharges

See page 5 for shading standards and page 8 for surcharges and pricing example.

Simplicity Rechargeable Motors

No special installation hardware or wiring requirements are needed to install motorized Shangri-La Shadings with Designer Cassette Head Rail. No external battery wand is required. See page 21 for mounting information.

Rechargeable Simplicity Motor Batteries

The battery for the integrated rechargeable simplicity motor system is integrated within the motor casing and is fully concealed by the roller tube.

Rechargeable battery comes fully charged from the factory.

Integrated Rechargeable Motor Battery Life

The rechargeable battery is concealed within the motor housing.

The average battery charge will last 6-12 months based on an average sized shade raised and lowered once per day. The life of the battery charge will vary based on the type of window covering selected, the size and weight of the window covering and the number of times the shade is operated on a daily basis.

The battery can be recharged up to 500 times. It takes approximately 5 hours to recharge the motor when fully depleted.

Integrated Rechargeable Motor Battery Charger

An 8.4 Volt charger requires a standard power outlet to recharge the battery. The charger must be specified when ordering an Integrated Rechargeable Simplicity Motorized shade. The charger plugs into the charging port of the motor. Required with Integrated Shading order. Sold separately.



The charger is black and comes with a 156" wire. The dimensions are 1" wide x 2½" length x 1¾" deep.

Simplicity Motor Hand Held Remotes

IMPORTANT: Simplicity Rechargeable Motorized Shadings are programmed at the factory with the "up and down" limits. The shades are **UNLINKED** from the remote so they are not able to operate during shipping. Each shade should be installed **before** linking it to the remote.

5 Channel Remote

The **5 Channel (5C) remote** can operate up to five shadings simultaneously, individually or in groups.

Simplicity (5C) remotes and holders are black or white in color. The remote comes with a holder which can be mounted to a wall for easy storage. The range of the remote is approximately 80 feet.



6 Channel Timer Remote

The **6 Channel (6C) timer remote** combines the functionality of a six channel hand-held control with the convenience of a programmable timer.

- The 6C timer remote allows for 18 different scheduled actions.
- Manual function disables the timer and the remote then operates as a hand held remote.

Simplicity (6C) remotes and holders are available in white. The remote comes with a holder which can be mounted to a wall for easy storage. The range of the remote is approximately 80 feet.



A **14 Channel (14C) remote** is also available. This remote is required for TDBU motorization but can be utilized on all Simplicity motorized shades. See page 23 for more information.

Please Note:

- Not all motors run at the same rate of speed.
- Simplicity motors have a "Favorites" or "MY" position setting. If the homeowner wants to set several shadings at the same intermediate position, follow instructions provided with installation manual.
- **WHEN ORDERING THE NEW INTEGRATED RECHARGEABLE, PLEASE ORDER THE NECESSARY BATTERY CHARGER.**

Solar Panel Recharge Option

Plugs in to any Simplicity Rechargeable Remote control shade (does not work with PowerTouch).

See page 25.

Color Lux® Sheer Shadings

7.4V RECHARGEABLE SIMPLICITY HARDWARE SYSTEM

Important Information about Integrated Rechargeable Simplicity Motor Shading Operation and Installation

- Simplicity Motorized Shadings installed into windows with metal casings may have a reduced radio frequency range, or may not operate at all, depending on control.
- Be mindful of when your shade starts to slow down during operation. It is a good indicator the shade needs to be recharged.

Simplicity Battery Operated Motorized Shadings Warranty

Please see page 114 for complete Comfortex warranty information.

NEW Simplicity Bluetooth Motorization

Learn about Simplicity Bluetooth motorization and Comfortex FREE Color Lux Mobile App on page 18.



Solar Panel Recharge Option

Plugs in to any Simplicity Rechargeable Remote control shade (does not work with PowerTouch)

Provides constant trickle charge to 7.4v Li-Ion Rechargeable battery packs. Will prolong the life of the charge of the 7.4v rechargeable battery packs, and in some applications will maintain charge indefinitely.

Life of charge is subject to application variables such as, size and weight of shade, frequency of use, amount of direct sunlight exposure, etc.

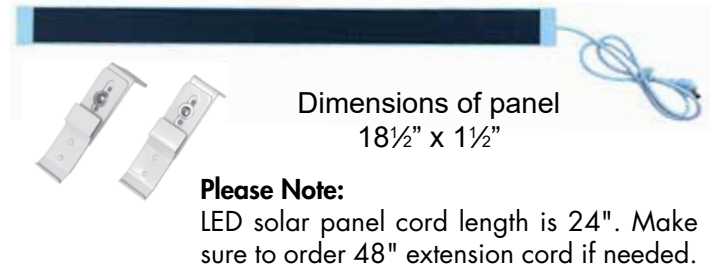

Solar Recharge Optimum Application

- Full direct sunlight (minimum 2 hours per day) to maintain full charge. Based on one operation cycle per day (one open, one close).
- Excessive duration of cloudy weather will impact the rate of charge.

Solar Panel LED Lights

Red Light: Indicates optimum direct sun exposure

Green Light: Indicates sunlight is enough to charge battery

Blue Light: Indicates battery is charging. Blue light is off when not charging (including when the battery is full)

No Lights: Night or very low sun

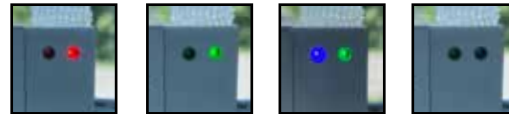

Red Light

Green Light

Blue Light

No Light

Solar Panel Mounting

Bottom portion of the bracket may be lowered if needed for more sun exposure. Bracket can be mounted behind or next to shade mounting bracket.

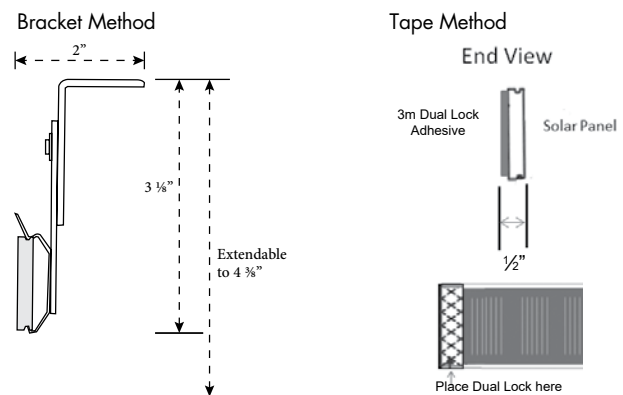

Tape goes on the face (black side) of the panel.

If the solar panel is mounted directly behind the headrail at the top of the window, you need to make sure that the solar panel does not interfere with the shade mounting brackets. The solar panel can go between brackets spaced apart, or behind brackets if the depth of the window casing allows.

Color Lux® Sheer Shadings

7.4V RECHARGEABLE SIMPLICITY HARDWARE SYSTEM

EZ Charge Extension Wand Option

EZ Charge Extension Wand is the newest innovation in rechargeable motorization. Easily charge your hard to reach Simplicity Rechargeable Shades with the EZ Charge Extension Wand. The wand extends up to 31" in length.

Simple to use! Place the magnetized wand tip on the receiving port to attach. Then plug the charger into the base of the wand. It is that simple!

- EZ Charge Extension Wand can be easily concealed by a valance or drapery panel.
- Great for out of reach windows

EZ Charge Wall Mount Receiver

- The EZ Charge Wall Mount Receiver includes screws and anchors. These can be used for wood or drywall mounting.
- Extension cable plugs into charging port of Simplicity Rechargeable shades.



EZ Charge Wall Mount Receiver Kit | CKIT078
One kit per Simplicity Motorized shade is needed.

EZ Charge Wand

- Wand is 9 1/2" and extends to 31"
- Magnetized tip makes connection quick and easy.
- Once wand is in place plug the 8.4v charger into the bottom of the extension wand for charging.

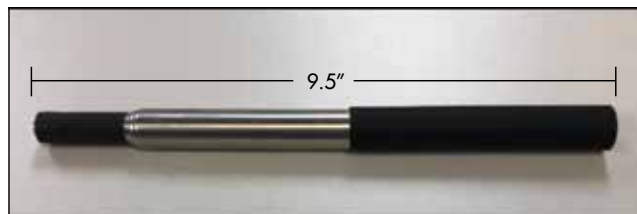

EZ Charge Wand | CKIT077
Order with the EZ Charge Wall Mount Receiver Kit



EZ Charge Receiving Port



Port/Wand Connection

Shade/Blind Product	EZ Charge Wall Mount Receiver List Price	EZ Charge Wand List Price
---------------------	--	---------------------------

Sheer	\$33	\$59
-------	------	------



Battery Charger



Wand Base

Battery Charger - SOLD SEPARATELY

You must specify charger when ordering a Simplicity Rechargeable Motorized Shade. The charger plugs into the wand base. The 8.4 Volt charger requires a standard power outlet to recharge the motor. The charger is black and comes with a 156" wire. The dimensions are 1" wide x 2 1/2" length x 1 3/4" deep.

Color Lux® Sheer Shadings

12V SIMPLICITY LOW VOLTAGE HARDWIRING SYSTEM

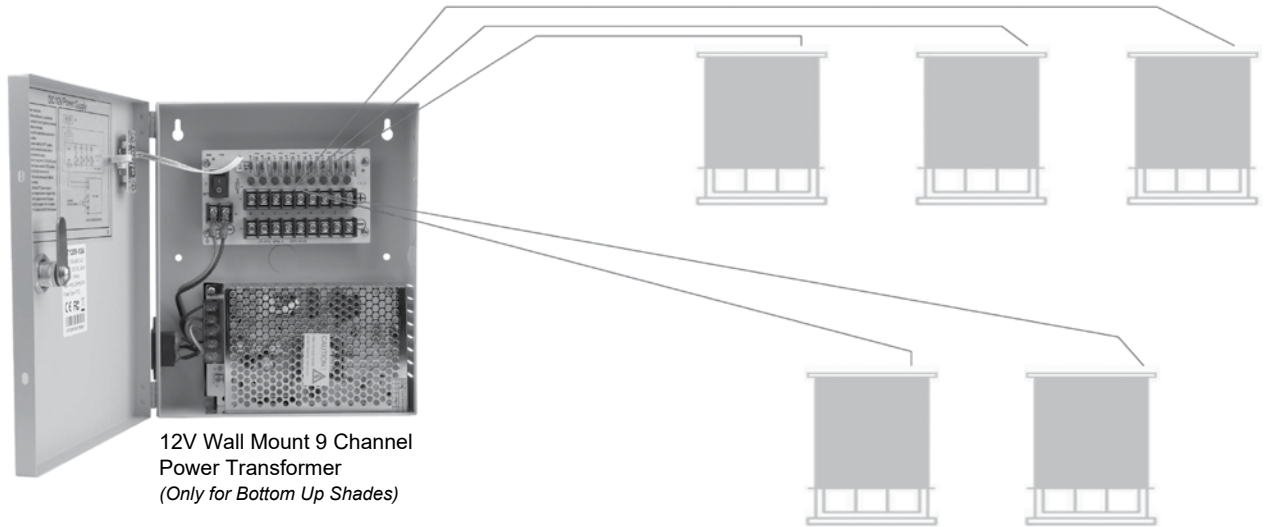

12V Wall Mount 9 Channel Power Transformer
(Only for Bottom Up Shades)

12V Low Voltage Hard Wired

Low Voltage hardwire powered motors are available for Roller Shades, Sheer Shadings and Cellular bottom up shades. The system offers a maintenance-free power option for Simplicity Motorized Shades. Our Simplicity power transformer mounts in a safe dry location (such as your basement), out of sight, and provides power for up to nine individual shades per box.

2 Conductor wires should be pre-installed by a licensed contractor according to local building codes, to connect power from the transformer to the shades.

Simply use the wire adapters provided to connect the power wire to the Simplicity motor power input on the back of the shade, then connect the pre-run wires to the (+ / -) terminal block in the transformer box, and flip on the power switch.

- Product Dimension: 7.875" wide, 9.4" Tall, 2.45" deep
- Converts incoming 120V AC to outgoing 12V for up to 9 shades.

• **Product Description:**

- 12v10a 9ch
- Input Voltage Range : AC90V-264V
- Input Frequency Range : 50Hz-60Hz
- Output Voltage Range : DC12V+/-5%
- Output Current : 10 Ampere
- Output Power : 120 Watt
- Output Ripple&Noise : ≤42MV
- Output Efficiency : ≥83%
- Output Fuse Type : PTC
- Output Fuse Rating : 2A
- Environment Operating Amb.Temp : -30 ~45
20%~90%RH
- Environment Storage Temp : -40 ~85 10%~95%RH
- Plugs into standard household outlet
- Power cord is 56" in length



2 Conductor Wires running to basement 12V Power Transformer

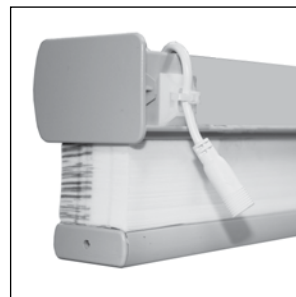

Power port on back of shade



Wires connecting to charging port on Simplicity shade



12V Wall Mount 9 Channel Power Transformer

Color Lux® Sheer Shadings
SIMPLICITY SMART CONTROLLER



Simplicity Smart Controller Dimensions

- Width of controller: 2³/₈"
- Length of controller: 2¹⁵/₁₆"
- Height of controller: 1¹/₈"

Simplicity Smart Controller

- Works with Apple and Android devices
- FREE Downloadable Application
- Compatible with previously installed Simplicity Remote Controlled Shades
- Powered by NEO Smart Blinds App.
- Compatible with Amazon Alexa, Google Assistant systems, Control4 and Savant systems

Simplicity Smart Controller

The Simplicity Smart Controller is a small device that you install in your home that allows you to set automatic opening and closing times for all Simplicity motorized shades as well as the ability to control your motorized shades from a phone, tablet or PC from anywhere in world.

The Simplicity Smart Controller will work with any Comfortex remote motorized shade with Simplicity remote control motors purchased after 2012.

The Simplicity Smart Controller plugs into a standard electrical outlet and connects to WiFi and sends signals to your shades using the same radio frequencies as a normal remote control.

How Does The NEO Smart Blinds App Work?

The app uses WiFi or cellular data to send commands over the internet to the Simplicity Smart Controller.

Do I Need Any Other Equipment?

Yes, The location where your shades are installed must have WiFi in order for the Simplicity Smart Controller to work. Additionally, you must have a smartphone or tablet running Android or iOS (eg. iPhone, iPad, Samsung Galaxy S7) and have the NEO Smart Blinds app. installed.

Why Would I Want A Simplicity Smart Controller?

There are two main ways the Simplicity Smart Controller adds additional value to your motorized shades. First, once all of your shades have been added, you can use your smartphone as a single remote for all of your shades that will work anywhere you are regardless of distance from the shade. Secondly, the device allows you to set schedules so your motorized shades automatically open and close without needing to do anything on a day to day basis.

Do I Need To Buy More Than 1 Controller?

The normal use for the Simplicity Smart Controller is to plug it in out of the way and forget it. Since it has roughly the same range as a remote you will want enough devices to allow all shades to be operated without moving the controller. So depending on the layout of the home and location of the shade, you might want multiple devices to have convenient full home coverage.

How Far Is The Range Of A Controller?

You should see a range of approximately 150 ft. However this number might be less depending on the layout of your home. In general we recommend one per a floor of a normal sized home.

Can I Control My Shades From Multiple Devices?

Yes! You can download the NEO Smart Blinds App onto multiple devices, After installing the App. on a new device simply log in with the same email/password on each device and you will have access to control your shades.

Can It Be Used With Already Installed Shades?

Yes! Simply follow the directions in the NEO Smart Blinds app. to add a shade. At the pairing step you can put the shade in pairing mode using the primary remote control (or by accessing the button on the shades motor). Adding the shade to the NEO Smart Blinds App. will not affect the normal remote operation.

How Much Does The NEO Smart Blinds App Cost?

The App is a free download, However you must have at least one Simplicity Smart Controller to serve as a bridge between the App and your shades.

Color Lux® Sheer Shadings

GENERAL INFORMATION

Certified Fabrics | GREENGUARD® Fabrics

GREENGUARD Environmental Institute has established performance based standards to define goods with low chemical and particle emissions for use indoors.

The Shangri-La fabrics have the passed GREENGUARD Indoor Air Quality Certified® certification program for low emitting interior building materials, furnishings, and finish systems.

Flame Resistance

Shangri-La fabric may be processed with a topical treatment to resist flames and adhere to strict flammability codes. For more information, contact Customer Service at (800) 843-4151.

UV Protection

Ultraviolet light, entering the home as sunlight, damages furnishings. In time it fades wood floors, furniture, upholstery, draperies, carpeting and artwork. Prolonged exposure to sunlight causes natural, undyed fabrics to turn yellow, weakening their fibers and making them look old and worn prematurely.

The right window covering can be very effective in blocking ultraviolet rays. Such effectiveness is measured in terms of a "% UV blockage" rating. The higher the rating, the greater the UV protection.

Shangri-La fabrics have the following UV Protection ratings:

Light Filtering Fabrics	Open Vanes	87%
Room Darkening Fabric	Open Vanes	88%
All Fabrics	Closed Vanes	99%

Vane Closure

Shangri-La vanes are not designed to close tightly. The inherent nature of the fabric will cause a slight increase in the distance from the front sheer to back sheer as you move further down the shading. These vanes do not form a perfect seal against light leakage which is most visible toward the bottom of the shading. Vane overlap ensures that privacy is not compromised.

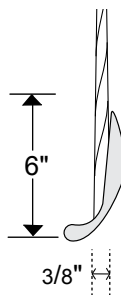

Vane closure is measured as the distance between the front and rear fabric sheers 6" up from the lowest point of the bottom rail, with the shading fully lowered and the vanes closed.

On light filtering fabrics, the maximum distance from the front sheer to the back sheer when closed is equal to or less than 3/8" for shadings under 60" and 5/8" for shadings longer than 60". On room darkening fabrics, the distance is 3/8" regardless of shading length.

Vane Opening and Visibility

Vaness on the three styles of Shangri-La fabrics open to slightly different degrees. Consequently, there are variations in visibility through the shadings when the vanes are tilted to their maximum open positions. The variations among the products are shown in the below illustration when looking through the shading 1/4 of the way up from the bottom.

3" Fabrics

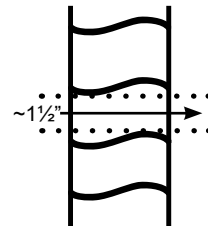

Magnetic Hold-Down Brackets

Optional magnetic hold-down brackets secure the bottom of the shading to prevent swaying. Please specify when ordering.

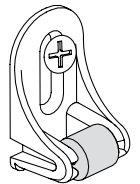

Extension Brackets

Extension or "L" brackets are available to project the back of the shading from the mounting surface. The extension brackets for Designer Cassette head rail projects it 3".

Spacer Blocks

Spacer blocks project the shading 3/8" from the mounting surface. Use spacer blocks to obtain clearance when obstructions, such as window cranks or door handles, obstruct the movement of the shading.

Leveling Shangri-La Sheer Shadings

Shangri-La Window Shadings are leveled and weighted in the factory. When installed level, the fabric will not skew when raised. If the head rail is not installed level, skewing can occur that can damage the edge of the fabric. Be sure to follow the installation instructions carefully to ensure correct and balanced operation.

Child Safety

Please see page 111 for child safety information.

Color Lux® Sheer Shadings

GENERAL INFORMATION

Measuring Instructions for Sheer Shadings

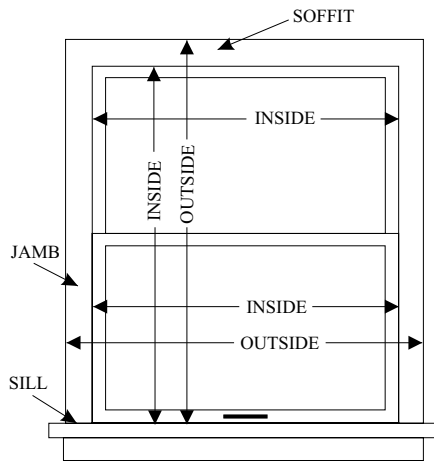

Important Measuring Guidelines for Sheer Shadings. Comfortex accepts measurements down to 1/16" increments.

Precise width and length measurements are critical. Fabric width cannot be altered after the shading is fabricated.

Please use a metal tape measure for accuracy.

The head rail must be installed perfectly level to ensure smooth operation. On an inside mount, it is recommended that you check to see that the mounting surface is level and consistent. If your soffit needs to be leveled, this should be done before measuring.

Inside Mount

Measure across the width of your window opening in three different places - top, middle and bottom. Measurements should be taken within the window jamb. Provide the smallest of the three measurements to Comfortex. Be exact. Comfortex will make the necessary deductions to fit the window opening.

Measure the length of the window opening from the underside of the soffit to the surface of the window sill in two places - use the smallest of these two measurements.

Outside Mount

Measure the exact width and length of the area to be covered. On the width, allow at least 1 1/2" of an overlap on each side. An overlap of 3" on each side is recommended. Be sure to take into consideration any obstructions such as window trim, molding, locks and window cranks.

Side Mount

Side mount is not available with DoorStyles Shadings.

Shangri-La may be side mounted using "L" brackets. For side mounts, follow the instructions for inside mounts. An additional 1/2" will be taken off the standard inside mount deduction to allow room for the "L" brackets.

The maximum shading width utilizing the side mount option is 48".

Skew Adjusting Bottom Rail

After installation, windows that are not square and level may cause the shadings to shift to one side as it rolls up, requiring adjustment of the bottom rail. If the brackets are not level it may be necessary to adjust the bottom rail weight.

- To access the bottom rail weight, release the weight clip on the bottom rail by using a flat blade screwdriver. Insert it into the weight clip in the bottom rail and turn clockwise.
- Move the weight in 1" increments toward the side where the fabric is gathering.
- Secure the weight clips in position by turning them counterclockwise after making the adjustment.

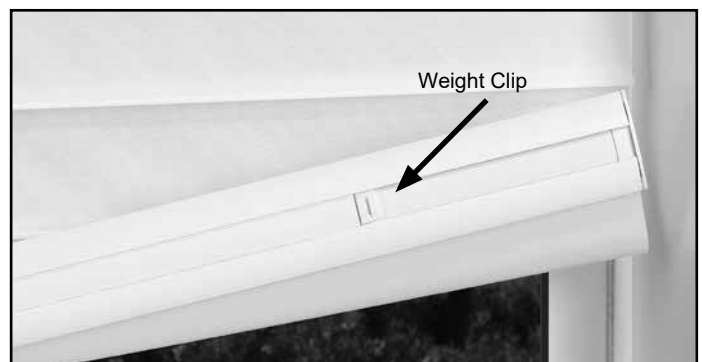

Cleaning and Care

Shangri-La Shadings are made from a sturdy, knitted polyester fabric which can be feather dusted or vacuumed at a low setting. Spots or stains can be lightly rubbed clean with a damp sponge and mild soap. To avoid discoloration of the material, we recommend against the use of chemical cleaners.

Precautions should be taken to reduce exposure to harsh environmental elements, such as salt air. Continuous exposure to salt air through open windows and doors will accelerate fabric deterioration over time.

Important: Do not clean the fabric using electrostatic wipes such as Swiffer® or Pledge Grab-It®.

Ultrasonic Cleaning

Shangri-La Shadings can be ultrasonically cleaned. Adco OnSite Fabricare provides shading and blind cleaning services. For more information, visit www.onsitefabricare.com. Comfortex acknowledges these cleaning methods as being safe and effective. We cannot attest to the quality of equipment or services provided by any independent cleaning facility.

For additional advice on care or cleaning, please contact the Comfortex Technical Service Department at 800-843-4151.







SHANGRI-LA® SHEER HORIZONTAL WINDOW SHADINGS

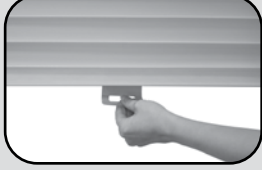

- Shangri-La is a window shading of unique beauty and performance for the finishing touch to a beautiful window and room.
- Horizontal fabric vanes float between two layers of soft, knitted fabric sheers to soften your view outside.
- Shangri-La is available to widths of 120" and drops to 13 2" to provide visual elegance to the widest of windows.
- Shangri-La is available in 2-inch, 2½-inch and 3-inch vane widths in both light filtering and room darkening fabrics.
- Shangri-La's 3-inch vane fabrics provide greater view through with our most popular colors.
- Vanes glide from open to closed to out of sight with elegant hardware.
- Choose from multiple hardware options to customize your shading: traditional cord loop, retractable cord, cordless, cordless PowerTouch with Touch and Go feature or Simplicity Integrated Rechargeable Motorization.
- Only the Omni-View cord system provides five distinctly different variations of vane position for numerous combinations of privacy, view and light control.
- Only with Shangri-La, can you partially raise the shading with the fabric vanes in the open, view-through position so you keep your view and still feel the outdoor breeze.
- A weight system in the bottom rail allows for on-the-spot skew adjustment for a balanced appearance in the window.
- The sophisticated array of Shangri-La colors is designed to flatter your decor.
- Create your customers own sophisticated look with the low light gap Designer Cassette Head Rail.
- A low side light gap provides minimal light leakage on shading sides and above the head rail for increased privacy.
- Easy to install hardware and brackets allow for effortless installations and easy removal for cleaning.
- Shangri-La Shadings may be ultrasonically or traditionally cleaned to stay bright and beautiful.
- A Limited Lifetime Warranty serves as a commitment to your satisfaction.
- **Now Available:** Color Lux Shangri-La Sheer Horizontal Shadings. 3" Vanes available in 25 printed patterns and hundreds of colors. Visualization and swatches available on www.colorluxwindowsolutions.com Complete program details available in the Color Lux Manufacturer's Price List and Reference Guide.

Sheer Horizontal Window Shadings
HARDWARE OPTIONS

SHANGRI-LA SHEER HORIZONTALS



	Key Features	Color Options	Hardware Size (Depth x Height)	Shade Size Available	More Information
<p>Cord Loop</p> 	<ul style="list-style-type: none"> • Cord Loop makes operation easy • Smooth & quiet operation • Braided cord loop is used to raise and lower the shading • Bead Cord is optional 	<ul style="list-style-type: none"> • White • Ivory • Onyx Black • Oil Rubbed Bronze • Brushed Nickel 	<p>Smooth Face: 3¾" x 2¾"</p> <p>Fabric Insert: 3¾" x 2⅞"</p>	<p>Width: 12" to 120"*</p> <p>Length: 12" to 132"***</p>	<p>Page 44</p>
<p>Retractable Cord</p> 	<ul style="list-style-type: none"> • Single Cord Design • Provides easy one hand operation • Maintains a consistent length • Enhances child and pet safety 	<ul style="list-style-type: none"> • White • Black • Bronze 	<p>Smooth Face: 3¾" to 2¾"</p> <p>Fabric Insert: 3¾" to 2⅞"</p>	<p>Width: 12" to 120"*</p> <p>Length: 12" to 72"</p>	<p>Page 45</p>
<p>Cordless Shading</p> 	<ul style="list-style-type: none"> • Cord Free • Roller catch mechanism in the head rail • Vanes easily adjusted into various positions 	<ul style="list-style-type: none"> • Clear handle • Bottom Rail is coordinated to the fabric (not matched to head rail) 	<p>Smooth Face: 3¾" to 2¾"</p> <p>Fabric Insert: 3¾" to 2⅞"</p>	<p>Width: 20" to 84"</p> <p>Length: 18" to 96"</p>	<p>Page 46</p>
<p>12V Non-Rechargeable Simplicity Motorization</p> 	<ul style="list-style-type: none"> • Raise & lower shade with click of a button • Great for large and hard to reach windows • Remote can operate multiple shades • Bluetooth Available 	<ul style="list-style-type: none"> • Designer Cassette options • 5 Channel Black or White Remote • 6 Channel white Remote with timer • 14 Channel white 	<p>Smooth Face: 3¾" to 2⅞"</p> <p>Fabric Insert: 3¾" to 2¾"</p>	<p>Width: 14" to 120"*</p> <p>Length: 12" to 132"***</p>	<p>Page 52</p>
<p>7.4V Rechargeable Simplicity Motorization</p> 	<ul style="list-style-type: none"> • Features a battery powered motor utilizing a rechargeable integrated battery pack • Raise & lower shading with click of a button • Great for large and hard to reach windows • Remote can operate multiple shades • Bluetooth Available 	<ul style="list-style-type: none"> • Designer Cassette options • 5 Channel Black or White Remote • 6 Channel white Remote with timer • 14 Channel white 	<p>Smooth Face: 3¾" to 2¾"</p> <p>Fabric Insert: 3¾" to 2⅞"</p>	<p>Width: 18" to 120"*</p> <p>Length: 12" to 132"***</p>	<p>Page 54</p>
<p>7.4V Rechargeable PowerTouch</p> 	<ul style="list-style-type: none"> • Raise & lower shading with push of a button • Eliminate the need to stand by the shading to operate; just touch and go • Favorite position button • Rechargeable battery with recharge port on pendant 	<ul style="list-style-type: none"> • Wand and pendant available in white or black 	<p>Smooth Face: 3¾" x 2¾"</p> <p>Fabric Insert: 3¾" x 2⅞"</p>	<p>Width: 18" to 120"*</p> <p>Length: 12" to 132"***</p>	<p>Page 50</p>

* Maximum width of 120" IB, 119¾" OB

** Light Filtering 132", Room Darkening 122"

Sheer Horizontal Window Shadings

HARDWARE OPTIONS

	Key Features	Color Options	Hardware Size (Depth x Height)	Shade Size Available	More Information
<p>Two-On-One Head Rail</p> 	<ul style="list-style-type: none"> • Operate two shades on one rail • Great for larger windows • Individually operating shades • Available with Cord Loop, PowerTouch Rechargeable, Simplicity and Retractable Cord • Not available with cordless • Bluetooth Available 	<ul style="list-style-type: none"> • White • Ivory • Onyx Black • Oil Rubbed Bronze • Brushed Nickel 	<p>Smooth Face: 3¾" x 2¾"</p> <p>Fabric Insert: 3¾" x 2⅞"</p>	<p>Individual Side Width: 12" to 102"</p> <p>Width: 24⅞" to 140"</p> <p>Length: See Designer Cassette Specs</p>	<p>Page 57</p>
<p>DoorStyles</p> 	<ul style="list-style-type: none"> • Great option for narrow windows, doors, sidelights or tilt-in windows • Does not raise/lower, articulate vanes only • No Pull cords 	<ul style="list-style-type: none"> • Rails and end caps are coordinated to the fabric color 	<p>2" x ½"</p>	<p>Width: 6" to 72"</p> <p>Length: 12" to 72" +</p>	<p>Page 48</p>
<p>Highlights Cornice Valance</p> 	<ul style="list-style-type: none"> • Accenting Fabrics • Adds height to windows • Available as inside and outside mount • Easy to install 	<ul style="list-style-type: none"> • 100+ Envision fabrics 	<p>Width: 12" to 94"</p> <p>Height: 6"</p> <p>Returns: 1½" to 6"</p>	<p>Varies by selected fabric</p>	<p>Page 108</p>

+ Maximum length varies by width

Sheer Horizontal Window Shadings

FABRIC COLLECTIONS

Shangri-La Sheer Horizontal Window Shadings are available with different fabric collections.

COLLECTION	2" Vanes	2½" Vanes	3" Vanes
Light Filtering	•	•	•
Room Darkening	•	•	•
Linen Light Filtering	•	NA	NA

Please Note: Room Darkening fabrics are not blackout fabrics. Knitted fabric may experience minor weave variations due to heat, humidity and other room conditions. These variations can result in light bowing, puckering and dimpling of the Shangri-La material. This is considered normal and does not constitute a failure in either workmanship or materials. The possible variations are minor and have been shown through case study not to detract from the beauty of the product.

Sheer Horizontal Window Shadings

HARDWARE OPTION AVAILABILITY

Use this table to ensure your coordinating options and unique shapes are consistent with your product selections.

CORD LOOP	2" Vanes	2" Linen Vanes	2½" Vanes	3" Vanes	Bluetooth
Cord Loop	•	•	•	•	NA
Cord Loop Two-On-One	•	•	•	•	NA
RETRACTABLE CORD					
Retractable Cord	•	•	•	•	NA
Retractable Cord Two-On-One	•	•	•	•	NA
CORDLESS SHADING					
Cordless Shading	•	•	•	•	NA
Cordless Shading Two-On-One	NA	NA	NA	NA	NA
SIMPLICITY MOTORIZATION					
Simplicity Motorization	•	•	•	•	NA
Simplicity Motorization Two-On-One	•	•	•	•	NA
SIMPLICITY RECHARGEABLE MOTORIZATION					
Simplicity Rechargeable	•	•	•	•	NA
Simplicity Rechargeable Two-On-One	•	•	•	•	NA
POWERTOUCH RECHARGEABLE MOTORIZATION					
PowerTouch Rechargeable	•	•	•	•	NA
PowerTouch Rechargeable Two-On-One	•	•	•	•	NA
DOORSTYLE					
DoorStyle	•	•	NA	•	NA



Smooth Face Designer Cassette



Fabric Insert Designer Cassette

Sheer Horizontal Window Shadings

SIZE STANDARDS



		Cord Loop	Retractable Cord	Cordless Shading	Motorization
ALL FABRICS	Minimum Width	12"	12"	20"	14"
	Minimum Length	12"	12"	12"	12"

Light Filtering	Price Group	Page		Cord Loop	Retractable Cord	Cordless Shading	Motorization
2" Vanes	5	39	Maximum Width & Length	120"* x 132"	120"* x 72"	84" x 96"	120"* x 132"
2" Linen Vanes	5	39					
2½" Vanes	7	40					
3" Vanes	9	41					

Room Darkening	Price Group	Page		Cord Loop	Retractable Cord	Cordless Shading	Motorization
2" Vanes	6	39	Maximum Width & Length	120"* x 122"	120"* x 72"	84" x 96"	120"* x 122"
2" Linen Vanes	6	39					
2½" Vanes	8	40					
3" Vanes	10	41					

	Cord Loop	Retractable Cord	Cordless Shading	Motorization
More Information On Page	Page 44	Page 45	Page 46	Page 52

* Maximum width of 120" IB, 119¾" OB

Sheer Horizontal Window Shadings

SIZE STANDARDS

SHANGRI-LA SHEER HORIZONTALS



		Motorization	Motorization	Two-On-One	DoorStyles
		Simplicity Rechargeable	PowerTouch Rechargeable		
ALL FABRICS	Minimum Width	18"	18"	See Table Below ⁺	6"
	Minimum Length	12"	12"	12"	12"

				Motorization	Motorization	Two-On-One	DoorStyles
				Simplicity Rechargeable	PowerTouch Rechargeable		
Light Filtering	Price Group	Page	Maximum Width & Length	120"* x 132"	120"* x 132"	140" x 132"	72" x 96"~
2" Vanes	5	39					
2" Linen Vanes	5	39					
2½" Vanes	7	40					
3" Vanes	9	41					

				Motorization	Motorization	Two-On-One	DoorStyles
				Simplicity Rechargeable	PowerTouch Rechargeable		
Room Darkening	Price Group	Page #	Maximum Width & Length	120"* x 122"	120"* x 122"	140" x 122"	72" x 96"~
2" Vanes	6	39					
2" Linen Vanes	6	39					
2½" Vanes	7	40					
3" Vanes	9	41					

				Motorization	Motorization	Two-On-One	DoorStyles
				Simplicity Rechargeable	PowerTouch Rechargeable		
More Information On Page				Page 52	Page 50	Page 57	Page 48

* Maximum width of 120" IB, 119¾" OB. ~ Maximum length varies by width. Maximum length for doorstyles over 36" wide is 72".

	Minimum Width	Hardware
TWO-ON-ONE HARDWARE ⁺	24"	Cord Loop
	24"	Retractable Cord
	NA	Cordless
	28"	Simplicity Motorization
	36"	Simplicity Rechargeable
	36"	PowerTouch Rechargeable

Sheer Horizontal Window Shadings

HARDWARE UPGRADE OPTIONS

LIFT SYSTEM	UPGRADES	ADD
Cord Loop	Bottom Up	Included
Retractable Cord	Bottom Up	\$106
Cordless Shading	Bottom Up	\$106

DESIGNER UPGRADE OPTIONS	UPGRADES	ADD
Add to Any Lift System Upgrade (Chart to the left)	Metallic Hardware	\$143
	Scotchgard Stain Protection	\$56
	Highlights Valance See Page 108 For More Information	

ADDITIONAL OPTIONS	UPGRADES	ADD
Add to Any Upgrade Above	Two-On-One Head Rail	Price as two shadings and add together.
Accessories	3 Foot Expandable Pole - Silver	\$35
	5-10 Foot Expandable Pole - Black	\$65

Sheer Horizontal Shading **Motorized** Hardware Upgrade Options

MOTORIZED	UPGRADES	ADD	
7.4V Rechargeable PowerTouch Wand System	Rechargeable Integrated Battery Pack	\$188	For More Information Page 50
	Plug-In Charger for Rechargeable Li-Ion	\$44	
7.4V Rechargeable Simplicity Accessories	Motor and Integrated Battery Pack	\$509	For More Information Page 54
	Plug-In Charger for Rechargeable Li-Ion	\$44	
	7.4v Solar Panel with mounting brackets	\$168	
7.4V EZ Charge Extension Wand	Wall Mount Receiver Kit	\$33	For More Information Page 26
	Extendable Wand	\$59	
12V Non-Rechargeable Simplicity Motorization System	Motor and Battery Wand	\$509	For More Information Page 52 & 27
	48" Extension Wire	\$29	
	Single Unit DC Power Supply/Transformer	\$118	
	9 Channel Wall Mount Low Voltage Hardwire Transformer (More info page 27)	\$420	
Simplicity Systems Controllers	NEO Controller	\$536	For More Information Pages 28, 55 & 80
	NEO Application for Mobile Devices	FREE	
	Simplicity 5 Channel Remote	\$65	
	Simplicity 6 Channel Remote with Timer	\$107	
	Simplicity 14 Channel White Remote	\$107	

Sheer Horizontal Window Shadings
HARDWARE UPGRADE OPTIONS

SHANGRI-LA SHEER HORIZONTALS



Shangri-La Sheer Horizontal Sheer Shading Pricing Examples

Two-On-One Pricing Example:

2" Light Filtering	
42" x 60" Shadings:	\$1148.00 x 2
	\$2296.00
Retractable Cord Upgrade:	\$106.00 x 2
	\$212.00
Total List Price:	\$2508.00

Simplicity Rechargeable Motorization Pricing Example:

2" Light Filtering	
42" x 60" Shadings:	\$1148.00
Metallic Hardware Option	\$143
Simplicity Rechargeable Surcharge:	\$509.00
Charger for Rechargeable (required):	\$44.00
Simplicity 5- Channel Remote:	\$65.00
Total List Price:	\$1909.00

Sheer Horizontal Window Shadings

PRICING

2" Light Filtering Vanes

PRICE GROUP 5 Cord Loop

		Width In Inches												
		24	30	36	42	48	54	60	66	72	84	96	108	120
Length In Inches	36	662	743	832	908	994	1082	1161	1247	1458	1637	1807	2192	2581
	42	698	786	874	971	1061	1159	1247	1336	1558	1750	1931	2354	2777
	48	739	834	935	1028	1127	1227	1333	1438	1661	1861	2060	2522	2980
	54	770	873	982	1089	1200	1306	1423	1541	1761	1971	2205	2761	3314
	60	805	923	1033	1148	1261	1391	1510	1638	1853	2097	2350	2949	3549
	66	841	966	1087	1210	1336	1471	1612	1743	1955	2229	2499	3136	3771
	72	874	1009	1141	1272	1412	1558	1700	1845	2060	2354	2646	3341	4033
	78	901	1045	1181	1327	1475	1628	1776	1932	2158	2475	2777	3510	4240
	84	938	1087	1230	1396	1551	1711	1877	2039	2270	2607	2928	3685	4449
	90	978	1127	1287	1456	1626	1805	1966	2139	2380	2731	3073	3890	4705
	96	1014	1176	1339	1522	1700	1878	2055	2235	2490	2858	3219	4085	4948
	102	1162	1344	1530	1730	1912	2086	2331	2559	2735	3112	3471	4198	5055
	108	1223	1414	1612	1821	2007	2201	2451	2695	2883	3270	3654	4420	5183
	114	1297	1500	1709	1931	2139	2339	2600	2857	3058	3471	3873	4688	5504
120	1396	1606	1835	2068	2281	2499	2778	3058	3271	3716	4147	5018	5884	
126	1485	1711	1954	2202	2434	2663	2963	3265	3488	3964	4421	5347	6279	
132	1583	1823	2081	2345	2592	2843	3157	3478	3718	4221	4711	5701	6690	

2" Room Darkening Vanes

PRICE GROUP 6 Cord Loop

		Width In Inches												
		24	30	36	42	48	54	60	66	72	84	96	108	120
Length In Inches	36	729	818	915	1000	1094	1190	1278	1371	1604	1801	1988	2412	2839
	42	768	866	961	1069	1167	1276	1371	1470	1714	1926	2124	2590	3055
	48	813	917	1028	1131	1241	1351	1467	1583	1828	2047	2266	2774	3279
	54	847	960	1081	1198	1321	1436	1566	1696	1937	2169	2425	3037	3646
	60	886	1016	1137	1263	1388	1530	1662	1802	2039	2307	2586	3245	3904
	66	925	1062	1196	1331	1470	1619	1774	1918	2151	2453	2750	3450	4149
	72	961	1110	1255	1399	1553	1714	1870	2031	2266	2590	2910	3676	4437
	78	991	1150	1299	1460	1624	1791	1954	2125	2375	2723	3055	3861	4664
	84	1032	1196	1354	1536	1706	1883	2066	2243	2497	2869	3221	4054	4894
	90	1076	1241	1416	1602	1789	1986	2162	2353	2618	3005	3381	4279	5175
	96	1116	1294	1473	1674	1870	2067	2261	2458	2739	3144	3542	4494	5443
	102	1279	1479	1684	1903	2104	2295	2565	2815	3009	3424	3818	4618	5560
	108	1346	1556	1774	2003	2208	2421	2696	2965	3172	3597	4020	4863	5703
	114	1427	1651	1880	2124	2353	2572	2861	3143	3363	3818	4261	5158	6055
120	1536	1767	2019	2275	2510	2750	3057	3363	3598	4088	4562	5520	6473	
122	1634	1883	2150	2422	2678	2930	3259	3591	3837	4360	4864	5883	6908	

LIFT SYSTEM	UPGRADES	ADD
Cord Loop	Bottom Up	Included
Retractable Cord	Bottom Up	\$106
Cordless Shading	Bottom Up	\$106

DESIGNER UPGRADE OPTIONS	UPGRADES	ADD
Add to Any Lift System Upgrade (Chart to the left)	Metallic Hardware	\$143
	Scotchgard Stain Protection	\$56
	Highlights Valance <i>See Page 108 For More Information</i>	

ADDITIONAL OPTIONS	UPGRADES	ADD
Add to Any Upgrade Above	Two-On-One Head Rail	Price as two shadings and add together.
Accessories	3 Foot Expandable Pole - Silver	\$35
	5-10 Foot Expandable Pole - Black	\$65

MOTORIZATION	MORE INFO
For motorization surcharges and options refer to page 37.	Pg 37

Shadings wider than 96": Shadings over 96" in width may require additional fabrication and delivery time.

Sheer Horizontal Window Shadings
PRICING

2 1/2" Light Filtering Vanes

PRICE GROUP 7
Cord Loop

		Width In Inches												
		24	30	36	42	48	54	60	66	72	84	96	108	120
Length In Inches	36	696	781	874	954	1045	1137	1220	1310	1531	1720	1898	2303	2710
	42	733	827	918	1020	1115	1218	1310	1403	1636	1838	2028	2472	2916
	48	776	876	982	1080	1184	1289	1400	1510	1744	1954	2163	2649	3130
	54	809	917	1032	1144	1261	1371	1495	1619	1849	2070	2315	2899	3480
	60	846	970	1085	1206	1325	1461	1587	1721	1946	2202	2468	3098	3727
	66	883	1014	1142	1270	1403	1545	1694	1831	2053	2342	2625	3293	3961
	72	918	1059	1198	1335	1483	1636	1785	1938	2163	2472	2778	3509	4235
	78	946	1097	1241	1394	1550	1709	1866	2029	2266	2599	2916	3686	4452
	84	985	1142	1292	1466	1629	1798	1972	2141	2384	2738	3075	3869	4672
	90	1027	1184	1352	1529	1707	1896	2065	2246	2499	2868	3227	4084	4940
	96	1066	1235	1406	1598	1785	1973	2158	2347	2615	3001	3381	4290	5196
	102	1221	1412	1607	1816	2008	2191	2449	2688	2872	3269	3645	4408	5308
	108	1285	1485	1694	1912	2108	2311	2573	2830	3028	3433	3837	4642	5443
114	1362	1575	1795	2028	2246	2456	2731	3000	3211	3645	4067	4923	5780	
120	1466	1687	1928	2172	2395	2625	2917	3211	3435	3902	4355	5269	6178	
126	1560	1798	2052	2312	2557	2797	3111	3428	3663	4163	4643	5615	6594	
132	1662	1914	2185	2462	2722	2985	3316	3652	3904	4433	4947	5986	7025	

2 1/2" Room Darkening Vanes

PRICE GROUP 8
Cord Loop

		Width In Inches												
		24	30	36	42	48	54	60	66	72	84	96	108	120
Length In Inches	36	766	860	961	1050	1150	1251	1343	1441	1685	1892	2088	2533	2982
	42	807	910	1011	1122	1227	1341	1441	1544	1800	2022	2230	2720	3209
	48	854	964	1081	1188	1302	1419	1540	1662	1919	2150	2380	2914	3443
	54	890	1009	1136	1258	1388	1509	1645	1781	2035	2277	2547	3189	3828
	60	932	1068	1194	1326	1458	1607	1745	1893	2141	2422	2716	3408	4100
	66	972	1116	1256	1398	1544	1700	1864	2014	2259	2577	2888	3623	4357
	72	1011	1165	1319	1469	1631	1800	1965	2133	2380	2720	3057	3860	4659
	78	1041	1208	1365	1534	1705	1880	2053	2231	2493	2860	3209	4055	4898
	84	1084	1256	1422	1613	1793	1978	2170	2355	2623	3012	3383	4256	5139
	90	1130	1302	1488	1682	1878	2085	2272	2470	2750	3155	3551	4493	5435
	96	1173	1359	1548	1759	1965	2171	2375	2582	2876	3302	3720	4720	5716
	102	1344	1553	1768	1999	2209	2411	2694	2957	3160	3596	4009	4849	5840
	108	1414	1634	1864	2104	2319	2543	2831	3113	3330	3778	4221	5106	5988
114	1499	1733	1975	2230	2470	2702	3005	3301	3532	4009	4474	5415	6359	
120	1613	1856	2121	2389	2635	2888	3210	3532	3779	4293	4791	5796	6796	
122	1716	1978	2258	2544	2813	3077	3422	3771	4030	4580	5107	6177	7254	

LIFT SYSTEM	UPGRADES	ADD
Cord Loop	Bottom Up	Included
Retractable Cord	Bottom Up	\$106
Cordless Shading	Bottom Up	\$106

DESIGNER UPGRADE OPTIONS	UPGRADES	ADD
Add to Any Lift System Upgrade (Chart to the left)	Metallic Hardware	\$143
	Scotchgard Stain Protection	\$56
	Highlights Valance See Page 108 For More Information	

ADDITIONAL OPTIONS	UPGRADES	ADD
Add to Any Upgrade Above	Two-On-One Head Rail	Price as two shadings and add together.
Accessories	3 Foot Expandable Pole - Silver	\$35
	5-10 Foot Expandable Pole - Black	\$65

MOTORIZATION	MORE INFO
For motorization surcharges and options refer to page 37.	Pg 37

Shadings wider than 96": Shadings over 96" in width may require additional fabrication and delivery time.

Sheer Horizontal Window Shadings

PRICING

3" Light Filtering Vanes

PRICE GROUP 9 Cord Loop

		Width In Inches												
		24	30	36	42	48	54	60	66	72	84	96	108	120
Length In Inches	36	729	818	915	1000	1094	1190	1278	1371	1604	1801	1988	2412	2839
	42	768	866	961	1069	1167	1276	1371	1470	1714	1926	2124	2590	3055
	48	813	917	1028	1131	1241	1351	1467	1583	1828	2047	2266	2774	3279
	54	847	960	1081	1198	1321	1436	1566	1696	1937	2169	2425	3037	3646
	60	886	1016	1137	1263	1388	1530	1662	1802	2039	2307	2586	3245	3904
	66	925	1062	1196	1331	1470	1619	1774	1918	2151	2453	2750	3450	4149
	72	961	1110	1255	1399	1553	1714	1870	2031	2266	2590	2910	3676	4437
	78	991	1150	1299	1460	1624	1791	1954	2125	2375	2723	3055	3861	4664
	84	1032	1196	1354	1536	1706	1883	2066	2243	2497	2869	3221	4054	4894
	90	1076	1241	1416	1602	1789	1986	2162	2353	2618	3005	3381	4279	5175
	96	1116	1294	1473	1674	1870	2067	2261	2458	2739	3144	3542	4494	5443
	102	1279	1479	1684	1903	2104	2295	2565	2815	3009	3424	3818	4618	5560
	108	1346	1556	1774	2003	2208	2421	2696	2965	3172	3597	4020	4863	5703
114	1427	1651	1880	2124	2353	2572	2861	3143	3363	3818	4261	5158	6055	
120	1536	1767	2019	2275	2510	2750	3057	3363	3598	4088	4562	5520	6473	
126	1634	1883	2150	2422	2678	2930	3259	3591	3837	4360	4864	5883	6908	
132	1741	2005	2289	2580	2852	3128	3474	3826	4090	4644	5182	6271	7360	

3" Room Darkening Vanes

PRICE GROUP 10 Cord Loop

		Width In Inches												
		24	30	36	42	48	54	60	66	72	84	96	108	120
Length In Inches	36	802	901	1007	1100	1205	1310	1405	1509	1765	1981	2187	2654	3123
	42	845	952	1058	1176	1285	1403	1509	1618	1886	2118	2338	2849	3361
	48	895	1009	1131	1245	1365	1487	1615	1741	2011	2252	2493	3052	3608
	54	933	1057	1189	1319	1454	1581	1723	1866	2131	2386	2668	3341	4010
	60	975	1118	1251	1390	1527	1684	1829	1982	2243	2537	2844	3569	4295
	66	1018	1170	1317	1465	1618	1781	1952	2111	2366	2699	3025	3795	4564
	72	1058	1221	1381	1539	1708	1886	2057	2235	2493	2849	3202	4043	4881
	78	1091	1265	1430	1606	1787	1970	2150	2339	2613	2996	3361	4247	5131
	84	1136	1317	1490	1691	1877	2072	2273	2467	2748	3156	3544	4459	5384
	90	1184	1365	1558	1763	1968	2185	2379	2589	2880	3306	3720	4708	5693
	96	1228	1424	1621	1842	2057	2274	2488	2704	3013	3459	3896	4944	5988
	102	1407	1627	1852	2093	2315	2525	2822	3098	3311	3767	4200	5080	6117
	108	1481	1711	1952	2204	2429	2663	2966	3261	3489	3958	4422	5350	6273
114	1570	1816	2069	2338	2589	2830	3147	3458	3700	4200	4687	5674	6660	
120	1691	1944	2221	2502	2761	3025	3362	3700	3959	4496	5019	6072	7121	
122	1798	2072	2365	2665	2946	3223	3586	3951	4221	4797	5351	6472	7599	

SHANGRI-LA SHEER HORIZONTALS

LIFT SYSTEM	UPGRADES	ADD
Cord Loop	Bottom Up	Included
Retractable Cord	Bottom Up	\$106
Cordless Shading	Bottom Up	\$106

DESIGNER UPGRADE OPTIONS	UPGRADES	ADD
Add to Any Lift System Upgrade (Chart to the left)	Metallic Hardware	\$143
	Scotchgard Stain Protection	\$56
	Highlights Valance <i>See Page 108 For More Information</i>	

ADDITIONAL OPTIONS	UPGRADES	ADD
Add to Any Upgrade Above	Two-On-One Head Rail	Price as two shadings and add together.
Accessories	3 Foot Expandable Pole - Silver	\$35
	5-10 Foot Expandable Pole - Black	\$65

MOTORIZATION	MORE INFO
For motorization surcharges and options refer to page 37.	Pg 37

Shadings wider than 96": Shadings over 96" in width may require additional fabrication and delivery time.

Sheer Horizontal Window Shadings

PRICING

2" Light Filtering Vanes

Limited color selection, see page 49.

PRICE GROUP 11

DoorStyles*

		Width In Inches											
		6	12	18	24	30	36	42	48	54	60	66	72
Length In Inches	12	565	577	594	606	676	761	816	834	924	942	963	1142
	18	566	585	599	617	693	780	844	863	958	984	1004	1203
	24	568	592	608	630	707	803	867	891	998	1021	1049	1256
	30	573	596	620	640	721	819	895	921	1034	1063	1090	1310
	36	576	599	629	667	746	836	912	1000	1086	1166	1253	1467
	42	617	648	677	701	791	878	975	1067	1164	1253	1344	1565
	48	636	672	765	743	838	939	1034	1133	1235	1339	1445	1668
	54	651	691	731	773	877	986	1094	1206	1314	1429	1550	1772
	60	673	714	755	808	927	1039	1153	1268	1397	1518	1647	1864
	66	711	755	806	844	971	1091	1215	1344	1478	1621	1750	1965
	72	731	782	836	878	1014	1146	1277	1418	1565	1709	1853	2071
	78	746	807	863	905	1049	1186						
	84	773	834	895	942	1091	1238						
90	794	861	926	983	1133	1292							
96	816	887	957	1018	1181	1348							

2" Room Darkening Vanes

Limited color selection, see page 49.

PRICE GROUP 12

DoorStyles*

		Width In Inches											
		6	12	18	24	30	36	42	48	54	60	66	72
Length In Inches	12	622	635	654	667	744	837	899	917	1017	1037	1059	1256
	18	623	643	660	679	763	858	929	949	1054	1083	1105	1323
	24	626	651	669	694	778	883	954	981	1097	1124	1154	1382
	30	631	656	682	705	794	902	984	1014	1138	1171	1199	1441
	36	634	660	692	734	821	920	1004	1100	1195	1284	1379	1615
	42	679	713	745	771	870	967	1073	1174	1281	1379	1479	1722
	48	700	740	842	818	922	1034	1138	1247	1359	1473	1590	1835
	54	717	760	804	850	966	1085	1205	1326	1446	1572	1705	1949
	60	741	786	832	889	1020	1143	1268	1396	1537	1670	1812	2050
	66	782	832	887	929	1069	1200	1336	1479	1626	1783	1926	2161
	72	804	861	920	967	1116	1261	1404	1560	1722	1880	2039	2278
	78	821	888	949	995	1154	1306						
	84	850	917	984	1037	1200	1362						
90	873	947	1019	1082	1247	1422							
96	899	977	1053	1120	1299	1483							

ADDITIONAL OPTIONS

Scotchgard Stain Protection	\$56
3 Foot Expandable Pole - Silver	\$35
5-10 Foot Expandable Pole - Black	\$65

*Rails and endcaps on Shangri-La DoorStyles Shadings are coordinated to the fabric color. Hardware used on DoorStyles may not match standard shadings. See page 49 for available colors.

Sheer Horizontal Window Shadings

PRICING

3" Light Filtering Vanes

Limited color selection, see page 49.

PRICE GROUP 13

DoorStyles*

		Width In Inches											
		6	12	18	24	30	36	42	48	54	60	66	72
Length In Inches	12	622	635	654	667	744	837	899	917	1017	1037	1059	1256
	18	623	643	660	679	763	858	929	949	1054	1083	1105	1323
	24	626	651	669	694	778	883	954	981	1097	1124	1154	1382
	30	631	656	682	705	794	902	984	1014	1138	1171	1199	1441
	36	634	660	692	734	821	920	1004	1100	1195	1284	1379	1615
	42	679	713	745	771	870	967	1073	1174	1281	1379	1479	1722
	48	700	740	842	818	922	1034	1138	1247	1359	1473	1590	1835
	54	717	760	804	850	966	1085	1205	1326	1446	1572	1705	1949
	60	741	786	832	889	1020	1143	1268	1396	1537	1670	1812	2050
	66	782	832	887	929	1069	1200	1336	1479	1626	1783	1926	2161
	72	804	861	920	967	1116	1261	1404	1560	1722	1880	2039	2278
	78	821	888	949	995	1154	1306						
	84	850	917	984	1037	1200	1362						
90	873	947	1019	1082	1247	1422							
96	899	977	1053	1120	1299	1483							

3" Room Darkening Vanes

Limited color selection, see page 49.

PRICE GROUP 14

DoorStyles*

		Width In Inches											
		6	12	18	24	30	36	42	48	54	60	66	72
Length In Inches	12	684	699	719	734	819	921	989	1009	1119	1141	1165	1382
	18	685	708	726	747	839	945	1022	1045	1160	1192	1216	1456
	24	689	717	736	764	856	972	1050	1080	1208	1238	1269	1521
	30	695	721	751	776	873	992	1083	1116	1252	1288	1320	1586
	36	698	726	762	808	904	1013	1105	1210	1315	1413	1517	1776
	42	747	785	820	848	957	1063	1181	1291	1410	1517	1627	1895
	48	770	814	926	901	1015	1138	1252	1371	1495	1621	1749	2019
	54	789	836	884	936	1062	1194	1325	1459	1591	1730	1876	2145
	60	815	866	915	979	1122	1257	1396	1536	1692	1838	1994	2255
	66	861	915	977	1022	1176	1321	1470	1627	1789	1963	2118	2378
	72	884	947	1013	1063	1228	1388	1545	1716	1895	2069	2243	2506
	78	904	978	1045	1095	1269	1436						
	84	936	1009	1083	1141	1321	1499						
90	960	1042	1121	1190	1371	1564							
96	989	1075	1159	1232	1430	1631							

ADDITIONAL OPTIONS

Scotchgard Stain Protection	\$56
3 Foot Expandable Pole - Silver	\$35
5-10 Foot Expandable Pole - Black	\$65

*Rails and endcaps on Shangri-La DoorStyles Shadings are coordinated to the fabric color.
 Hardware used on DoorStyles may not match standard shadings.
 See page 49 for available colors.

Sheer Horizontal Window Shadings

CORD LOOP SHADING HARDWARE SYSTEM | DESIGNER CASSETTE HEAD RAIL



Smooth Face

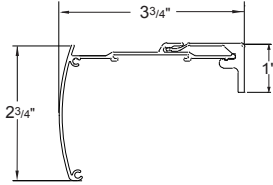

Smooth Face Designer Cassette Head Rail

- Depth of rail and bracket: 3 3/4"
- Height of rail: 2 3/4"
- Height of bracket: 1"

Fabric Insert

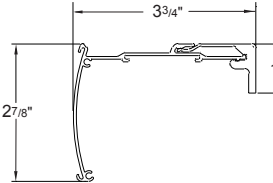

Fabric Insert Designer Cassette Head Rail

- Depth of rail and bracket: 3 3/4"
- Height of rail: 2 7/8"
- Height of bracket: 1"

Hardware Features

Standard Designer Cassette	Choose from coordinating Fabric Insert or painted Smooth Face rail. Default head rail color is White or Ivory based on shading vane color.
Bottom Rail Color	Color coordinated rail with White/Ivory head rail. Bottom rail will be matched to Oil Rubbed Bronze or Onyx Black when metallic upgrade is selected. With Brushed Nickel Head rail, bottom rail will be coordinated to fabric.

Upgrades

Designer Metallic Upgrade (Fabric Insert/Smooth Face)	<ul style="list-style-type: none"> • Oil Rubbed Bronze • Onyx Black • Brushed Nickel
---	---

Mounting Dimensions	Designer Cassette Head Rail
Minimum Shallow Mount	1"
Minimum Flush Inside Mount (including brackets)	3 3/4"
Minimum Outside Mount	1"
Minimum Side Mount	1 1/4"
Width Side Mount	48" Max width side mount

Finished Dimensions

Inside Mount	
	<ul style="list-style-type: none"> • Fabric will measure ordered width less: 1" • Head rail* will measure ordered width less: 3/16"
Side (End) Mount	
	<ul style="list-style-type: none"> • Fabric will measure ordered width less: 1 1/2" • Head rail* will measure ordered width less: 1/16"
Outside Mount	
	<ul style="list-style-type: none"> • Fabric will measure ordered width less: 5/8" • Head rail* will measure ordered width plus: 3/16"
Exact (End Cap to End Cap) Mount	
	<ul style="list-style-type: none"> • Fabric will measure ordered width less: 13/16" • Head rail* will measure ordered width

* Head rail measurements include endcaps. Width and length measurements may vary +/- 1/8"

Please Note: Once ordered and manufactured, the width of the Shangri-La fabric cannot be altered. Comfortex makes deductions to the width depending on the type of mounting indicated. For all mounting types, fabric will measure exactly the length ordered when the vanes are in the closed position.

Sheer Horizontal Window Shadings

RETRACTABLE CORD HARDWARE SYSTEM | DESIGNER CASSETTE HEAD RAIL

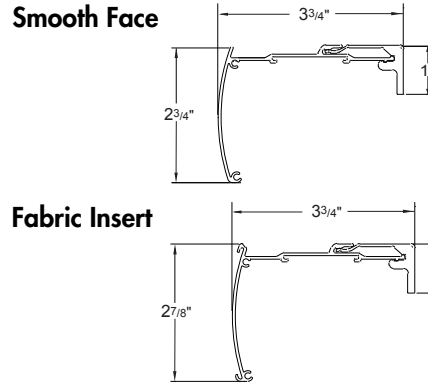

- Smooth Face Designer Cassette Head Rail**
- Depth of rail and bracket: 3 3/4"
 - Height of rail: 2 3/4"
 - Height of bracket: 1"
- Fabric Insert Designer Cassette Head Rail**
- Depth of rail and bracket: 3 3/4"
 - Height of rail: 2 7/8"
 - Height of bracket: 1"

Hardware Features	
Standard Designer Cassette	Choose from coordinating Fabric Insert or painted Smooth Face rail. Default head rail color is White or Ivory based on shading vane color.
Bottom Rail Color	Color coordinated rail with White/Ivory head rail. Bottom rail will be matched to Oil Rubbed Bronze or Onyx Black when metallic upgrade is selected.
Upgrades	
Designer Metallic Upgrade (Fabric Insert/Smooth Face)	<ul style="list-style-type: none"> • Oil Rubbed Bronze • Onyx Black
Mounting Dimensions	
Finished Dimensions	
Mounting and Finished Dimensions are the same as Cord Loop See Page 44	

Retractable Cord Shadings

The Retractable Cord option is a single cord design that provides easy one hand operation to raise, lower and open and close the vanes.

- Retractable Cord hardware is an alternative to conventional cord loop controls. The short retractable cord maintains a consistent length whether the shadings are raised or lowered. The elimination of cord loop enhances child and pet safety.
- Available with all fabrics with Designer Cassette.
- White, black or bronze cord and tassel coordinates your hardware color choice.
- Standard cord length is 40% the length of the shading. Cord may be shortened to match consumer operating preferences and to keep out of reach of children. Cord length can be easily modified in the field.
- Mounting a cord tensioner is not necessary. Cord cleat is recommended.

Overall Operation

When raising and lowering the shading, pull the cord down in long, even strokes. Allow the cord to fully retract into the head rail after each downward stroke.

To Lower The Shading And Open The Vanes

- Pull the cord down toward the center of the shading with long strokes. Continue until the shading is fully lowered and the vanes are open.
- Allow the cord to retract completely into the head rail after each downward stroke.
- The shading can be stopped at any point while lowering

To Tilt The Vanes And Raise Shading

- Pull the cord straight down or down and slightly out with long strokes. With each stroke the shading partially raises.
- Allow the cord to retract completely into the head rail after each downward stroke.
- Use multiple strokes until the shading reaches the desired position.
- The shading can be stopped at any point while raising.

Sheer Horizontal Window Shadings

CORDLESS HARDWARE SYSTEM | DESIGNER CASSETTE HEAD RAIL

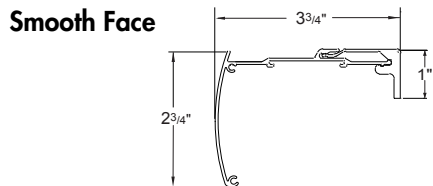
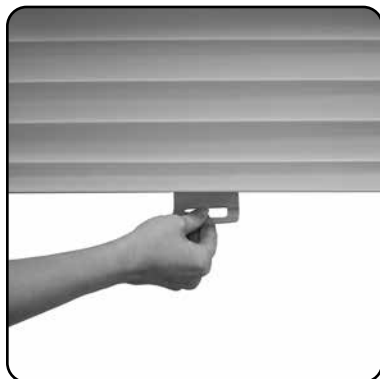

- Smooth Face Designer Cassette Head Rail**
- Depth of rail and bracket: 3 3/4"
 - Height of rail: 2 3/4"
 - Height of bracket: 1"

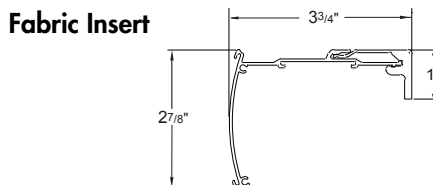

- Fabric Insert Designer Cassette Head Rail**
- Depth of rail and bracket: 3 3/4"
 - Height of rail: 2 7/8"
 - Height of bracket: 1"

Hardware Features

Standard Designer Cassette	Choose from coordinating Fabric Insert or painted Smooth Face rail. Default head rail color is White or Ivory based on shading vane color.
Bottom Rail Color	Color coordinated rail with White/Ivory head rail. Bottom rail will be matched to Oil Rubbed Bronze or Onyx Black when metallic upgrade is selected. Hinged handle is clear. With Brushed Nickel Head rail, bottom rail will be coordinated to fabric.
Upgrades	Available for all Designer Cassette Head Rails
Designer Metallic Upgrade (Fabric Insert/Smooth Face)	<ul style="list-style-type: none"> • Oil Rubbed Bronze • Onyx Black • Brushed Nickel

Mounting Dimensions

	Designer Cassette Head Rail
Minimum Shallow Mount	1"
Minimum Flush Inside Mount (including brackets)	3 3/4"
Minimum Outside Mount	1"
Minimum Side Mount	1 1/4"
Maximum Side Mount	48"

Finished Dimensions

Inside Mount

	<ul style="list-style-type: none"> • Fabric will measure ordered width less: 7/8" • Head rail* will measure ordered width less: 3/16"
--	---

Side (End) Mount

	<ul style="list-style-type: none"> • Fabric will measure ordered width less: 1 3/8" • Head rail* will measure ordered width less: 1 1/16"
--	---

Outside Mount

	<ul style="list-style-type: none"> • Fabric will measure ordered width less: 1/2" • Head rail* will measure ordered width plus: 3/16"
--	---

Exact (End Cap to End Cap) Mount

	<ul style="list-style-type: none"> • Fabric will measure ordered width less: 1 1/16" • Head rail* will measure ordered width
--	--

* Head rail measurements include endcaps. Width and length measurements may vary +/- 1/8"

Please Note: Once ordered and manufactured, the width of the Shangri-La fabric cannot be altered. Comfortex makes deductions to the width depending on the type of mounting indicated. For all mounting types, fabric will measure exactly the length ordered when the vanes are in the closed position.

Sheer Horizontal Window Shadings

CORDLESS HARDWARE SYSTEM | DESIGNER CASSETTE HEAD RAIL

Cordless Shangri-La Shadings Head Rail

- The Standard Designer Cassette head rail is with white or ivory aluminum with a coordinating fabric insert or Smooth Face.
- Designer Cassette head rail is also available in Oil Rubbed Bronze, Brushed Nickel and Onyx Black.
- Shangri-La Cordless Sheer Horizontal Shadings use quick-snap, no-light-gap brackets.

Cordless Shangri-La Shadings Bottom Rail

- Bottom rail includes sliding weight to adjust fabric skewing if necessary.
Please note: On Cordless Shangri-La Shadings the bottom rail is color coordinated to the fabric (not matched to the head rail). Hinged handle is clear.

Operating A Cordless Shangri-La Shading

Cordless Shangri-La Shadings utilize a roller catch mechanism in the head rail which allows for the vanes to be adjusted into various positions.

Pull the handle that is attached to the bottom rail until the shading reaches the desired length, allow catch mechanism to engage and lock shade in desired position.

To Open Or Close Vanes

Lower the shading all the way down and continue pulling down on the handle until the vanes open. The roller catch mechanism allows the vanes to be adjusted open, closed and to various positions in between.

When adjusting the vane position, release the catch by tugging on the handle, roll up the shading several inches (this resets the catch mechanism), then pull back down to the desired position.

- The Omni-View setting is not available with Shangri-La Cordless Shadings.

To Raise The Shading

Pull down on the handle to release the catch mechanism and let the shading rise. Tug the handle to lock the shade in the desired position.

When first learning to operate the shading, it may take a few tries to get the feel of the mechanism.



Cordless Handle

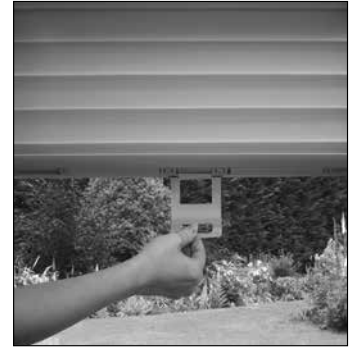

Cordless Handle Being Pulled Down



Cordless Handle on Window Sill

Sheer Horizontal Window Shadings

SHANGRI-LA DOORSTYLES HARDWARE SYSTEM

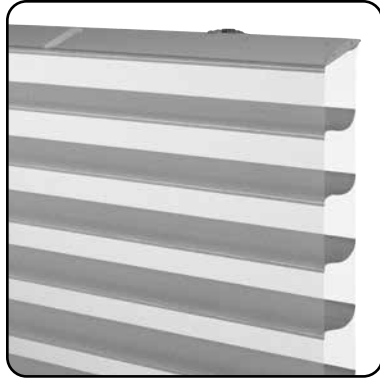

Limited color selection, see page 49.

SHANGRI-LA SHEER HORIZONTALS

Hardware Features	
Standard Hardware	Hardware used on DoorStyles Shadings may not match standard shadings.
Bottom Rail Color	Rails and end caps on Shangri-la DoorStyles Shadings are coordinated to the fabric color. With Brushed Nickel Head rail, bottom rail will be coordinated to fabric.
Upgrades	
Designer Metallic Upgrade	Not Available
Hinges & Handle	Polished Brass
Mounting Dimensions	
DoorStyles Hardware	
Minimum Shallow Mount	1½"
Minimum Flush Inside Mount (including brackets)	2 ⁵ / ₈ "
Minimum Outside Mount	¾"
Finished Dimensions	
Inside Mount	
	<ul style="list-style-type: none"> • Fabric will measure ordered width less: 5/16" • Head rail* will measure ordered width less: 3/16"
Outside Mount	
	<ul style="list-style-type: none"> • Fabric will measure ordered width • Head rail* will measure ordered width plus: 3/16"
Exact (End Cap to End Cap) Mount	
	<ul style="list-style-type: none"> • Fabric will measure ordered width less: 3/16" • Head rail* will measure ordered width
* Head rail measurements include endcaps. Width and length measurements may vary +/- 1/8" Side Mount is not available for DoorStyles	

Please Note: Once ordered and manufactured, the width of the Shangri-La fabric cannot be altered. Comfortex makes deductions to the width depending on the type of mounting indicated.

Sheer Horizontal Window Shadings

SHANGRI-LA DOORSTYLES HARDWARE SYSTEM

Shangri-La DoorStyles Shadings

Shangri-La DoorStyles Shadings cover French doors, transoms and sidelights for a look of sheer perfection without a bulky head rail. They attach to the window frame or door with unobtrusive hinges and tilt open and closed with easy to install hardware. An operating handle allows the fabric to be tilted open and closed (Figure A). Hardware used on DoorStyle Shadings may not match standard shadings.

Fabric

Only listed 2" and 3" light filtering and room darkening fabrics are available as DoorStyle Window Shadings. See chart below.

DoorStyles are **not** available with 2½" fabrics.

Rails and end caps on Shangri-La DoorStyles Shadings are coordinated to the fabric color.

2" VANE	3" VANE
1000 Powder	31000 Powder
1001 Vellum	31001 Vellum
3001 Vellum Aura™	33001 Vellum Aura™
2100 Starlight	32100 Starlight
2200 Cloud White	32200 Cloud White

Designer Metallic Hardware Upgrade: Not available with DoorStyles.

Operating Pole

An operating pole is available for hard to reach windows and doors. Please specify when ordering.

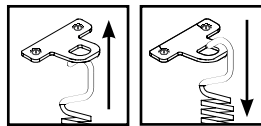

3 Foot Expandable Pole

5-10 Foot Expandable Pole

DoorStyles Shading Specifications

Minimum Width: 6" Maximum Width: 72"

Minimum Length: 12" Maximum Length: 72"*

*Maximum length varies by width.

DoorStyles are **not** available with 2½" vane fabrics.

Please Note: Once ordered and manufactured, the width of the Shangri-La fabric cannot be altered. Comfortex makes deductions to the width depending on the type of mounting indicated. For all mounting types, fabric will measure exactly the length ordered when the vanes are in the open or "view-through" position.

Length Considerations With Shangri-La DoorStyles

Comfortex will fabricate your Shangri-La DoorStyles to the length ordered when the vanes are in the open (or view through) position. When the vanes are tilted to the closed position, the shading will become 1¾" longer.

When closed on an inside mount or when used with hold down brackets, a slight puckering may occur.

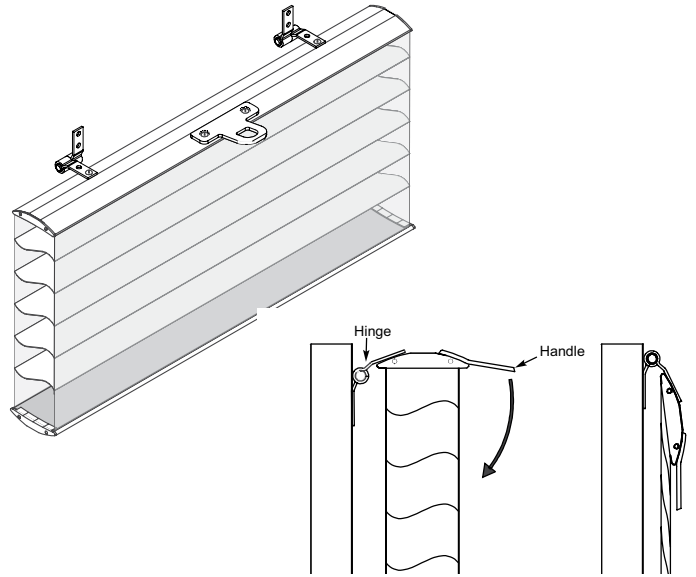
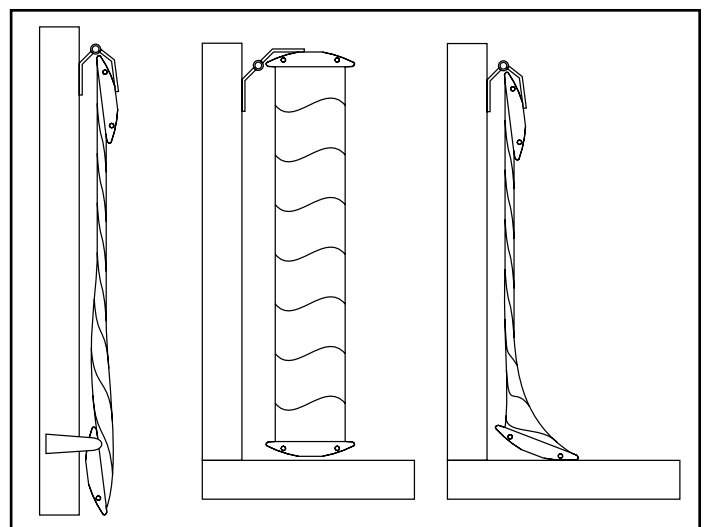
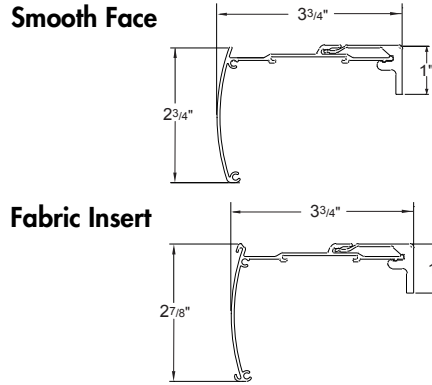

Figure A



Sheer Horizontal Window Shadings

7.4V RECHARGEABLE POWERTOUCHE HARDWARE SYSTEM | DESIGNER CASSETTE HEAD RAIL



- Smooth Face Designer Cassette Head Rail**
- Depth of rail and bracket: 3 3/4"
 - Height of rail: 2 3/4"
 - Height of bracket: 1"

- Fabric Insert Designer Cassette Head Rail**
- Depth of rail and bracket: 3 3/4"
 - Height of rail: 2 7/8"
 - Height of bracket: 1"

Hardware Features	
Standard Designer Cassette	Choose from coordinating Fabric Insert or painted Smooth Face rail. Default head rail color is White or Ivory based on shading vane color.
Bottom Rail Color	Color coordinated rail with White/Ivory head rail. Bottom rail will be matched to Oil Rubbed Bronze or Onyx Black when metallic upgrade is selected. With Brushed Nickel Head rail, bottom rail will be coordinated to fabric.
Upgrades	Available for all Designer Cassette Head Rails
Designer Metallic Upgrade (Fabric Insert/Smooth Face)	<ul style="list-style-type: none"> • Oil Rubbed Bronze • Onyx Black • Brushed Nickel
Mounting Dimensions	
Designer Cassette Head Rail	
Minimum Shallow Mount	1"
Minimum Flush Inside Mount (including brackets)	3 3/4"
Minimum Outside Mount	1"
Minimum Side Mount	1 1/4"
Width Side Mount	48" Max width side mount
Finished Dimensions	
Inside Mount	
	<ul style="list-style-type: none"> • Fabric will measure ordered width less: 1" • Head rail* will measure ordered width less: 3/16"
Side (End) Mount	
	<ul style="list-style-type: none"> • Fabric will measure ordered width less: 1 1/2" • Head rail* will measure ordered width less: 1 1/16"
Outside Mount	
	<ul style="list-style-type: none"> • Fabric will measure ordered width less: 5/8" • Head rail* will measure ordered width plus: 3/16"
Exact (End Cap to End Cap) Mount	
	<ul style="list-style-type: none"> • Fabric will measure ordered width less: 1 3/16" • Head rail* will measure ordered width
* Head rail measurements include endcaps. Width and length measurements may vary +/- 1/8"	

Please Note: Once ordered and manufactured, the width of the Shangri-La fabric cannot be altered. Comfortex makes deductions to the width depending on the type of mounting indicated. For all mounting types, fabric will measure exactly the length ordered when the vanes are in the closed position.

Sheer Horizontal Window Shadings

7.4V RECHARGEABLE POWERTOUCH HARDWARE SYSTEM | DESIGNER CASSETTE HEAD RAIL

PowerTouch™ Rechargeable Shades

Sheer Shadings can be fabricated with the PowerTouch Rechargeable Push Button Control option. The PowerTouch Rechargeable option is an easy, cord free motorized operation for the budget savvy homeowner. PowerTouch Rechargeable uses Simplicity motors and components.

PowerTouch Rechargeable Shades Operation

Press the up or down button on the pendant to raise or lower the shading to your desired position. When the shading is fully lowered to the factory programmed lower limit, the bottom rail will be set in the level position.

No programming is required with PowerTouch™, all programming is set at the factory. Upper and lower limits can easily be adjusted in the field if desired. Please refer to the installation instructions at comfortex.com/comfortex-dealers. Favorites position can be programmed on-site.

PowerTouch Rechargeable Surcharges

See page 37.

PowerTouch Appearance

- The PowerTouch Rechargeable wand and pendant is attached to the head rail and requires no additional mounting.
- The wand and pendant hangs down the front of the shades from the head rail. The wand does not touch the fabric.
- Pendant is 2½" long.
- The pendant does not need to be mounted to the wall to operate the shade.



PowerTouch Rechargeable Color Options

- Shadings with Black or Oil Rubbed Bronze hardware will be built with black wand and pendants standard. All other colors will use white wand and pendants.



White



Black Shown with Plug-In Charger

PowerTouch Wand and Pendant Location

The standard location for the wand and pendant is on the right. Please specify location when ordering.

PowerTouch Rechargeable Wand Length

The standard length of the wand will measure the indicated below unless otherwise specified.

Shading Length	Standard Wand Length
Up to 30"	1' (12")
>30" to 52"	2' (24")
>52" to 78"	3' (36")
>78" to 100"	4' (48")
>100" to 120"	5' (60")

- Wand length is in 1 foot increments. 1 foot - 5 foot

Mounting Requirements for PowerTouch Rechargeable Shadings

- No special installation hardware or wiring requirements are needed.
- The wand and pendant do not need to be mounted to operate the shading.

PowerTouch Rechargeable Battery Life

The battery life will vary based on the type of window covering selected, the size and weight of the window covering and the number of times you operate the blind on a daily basis.

The average battery charge will last 6-12 months based on an average sized shade raised and lowered once per day. The life of the battery charge will vary based on the type of window covering selected, the size and weight of the window covering and the number of times the shade is operated on a daily basis.

The battery can be recharged up to 500 times. It takes approximately 5 hours to recharge the motor when fully depleted.

Battery Charger

8.4 Volt charger requires a standard power outlet to recharge the battery. Must specify charger when ordering a Simplicity PowerTouch Rechargeable Shading. The charger plugs into the charger port. The charger is black and comes with a 156" wire. The dimensions are 1" wide x 2½" length x 1¾" deep.



PowerTouch Rechargeable Shadings Warranty

Please see page 114 for complete warranty information.

NEW Simplicity Bluetooth Motorization

Learn about Simplicity Bluetooth motorization and Comfortex FREE Color Lux Mobile App on page 18.

Sheer Horizontal Window Shadings

12V SIMPLICITY MOTORIZATION | DESIGNER CASSETTE HEAD RAIL



Smooth Face

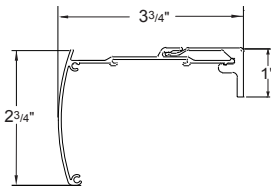

Smooth Face Designer Cassette Head Rail

- Depth of rail and bracket: 3 3/4"
- Height of rail: 2 3/4"
- Height of bracket: 1"

Fabric Insert

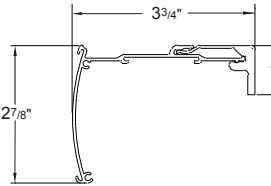

Fabric Insert Designer Cassette Head Rail

- Depth of rail and bracket: 3 3/4"
- Height of rail: 2 7/8"
- Height of bracket: 1"

Hardware Features

Standard Designer Cassette	Choose from coordinating Fabric Insert or painted Smooth Face rail. Default head rail color is White or Ivory based on shading vane color.
Bottom Rail Color	Color coordinated rail with White/Ivory head rail. Bottom rail will be matched to Oil Rubbed Bronze or Onyx Black when metallic upgrade is selected.
Upgrades	Available for all Designer Cassette Head Rails
Designer Metallic Upgrade (Fabric Insert/Smooth Face)	<ul style="list-style-type: none"> • Oil Rubbed Bronze • Onyx Black • Brushed Nickel

Mounting Dimensions

Mounting Dimensions	Designer Cassette Head Rail
Minimum Shallow Mount	1"
Minimum Flush Inside Mount (including brackets)	3 3/4"
Minimum Outside Mount	1"
Minimum Side Mount	1 1/4"
Width Side Mount	48" Max width side mount

Finished Dimensions

Inside Mount	
	<ul style="list-style-type: none"> • Fabric will measure ordered width less: 1" • Head rail* will measure ordered width less: 3/16"
Side (End) Mount	
	<ul style="list-style-type: none"> • Fabric will measure ordered width less: 1 1/2" • Head rail* will measure ordered width less: 1 1/16"
Outside Mount	
	<ul style="list-style-type: none"> • Fabric will measure ordered width less: 5/8" • Head rail* will measure ordered width plus: 3/16"
Exact (End Cap to End Cap) Mount	
	<ul style="list-style-type: none"> • Fabric will measure ordered width less: 1 3/16" • Head rail* will measure ordered width

* Head rail measurements include endcaps. Width and length measurements may vary +/- 1/8"

Please Note: Once ordered and manufactured, the width of the Shangri-La fabric cannot be altered. Comfortex makes deductions to the width depending on the type of mounting indicated. For all mounting types, fabric will measure exactly the length ordered when the vanes are in the closed position.

Sheer Horizontal Window Shadings

12V SIMPLICITY MOTORIZATION | DESIGNER CASSETTE HEAD RAIL

Simplicity Motors

The Simplicity Motor program features a battery powered motor utilizing a single battery wand or plug-in DC transformer. Simplicity motors are compact and use a radio frequency remote to raise or lower the shadings. The Simplicity motor is concealed in the head rail.

See page 50 for information on Simplicity Rechargeable system version.

Simplicity Motors With Designer Cassette

No special installation hardware or wiring requirements are needed to install motorized Shangri-La Shadings with Designer Cassette Head Rail. See page 52 for mounting information.

Simplicity Battery Wand

The battery wand can be clipped to the Designer Cassette head rail. Can not be mounted on shadings under 25" wide. The battery wand is wall or ceiling mounted utilizing white battery wand clips. The 12 volt battery wand measures 17¼", and comes with eight alkaline batteries, and is white in color. The battery wand must be placed so it does not interfere with the mounting brackets.

The battery wire is 10" long. A 48" extension wire is available.



Simplicity Motor Battery Life and Replacement

Eight alkaline batteries are included with the wand.

The battery life will vary based on the type of window covering selected, the size and weight of the window covering and the number of times you operate the shade on a daily basis.

Comfortex will warranty batteries for up to 3 months from date of purchase. Batteries are not covered by the warranty.

DC Power Supply/Transformer

12 Volt DC power supply/transformer is available and requires a standard power outlet to power the motor. The transformer is an alternative to a battery wand. Each transformer can power a single shading. The power supply must plug in to the motor. The DC power supply is white and comes with a 80" wire. The dimensions are 1⅞" wide x 3¼" long x 1¼" deep. Extension wires are available if needed.



Important Simplicity Motorized Shading Operating and Installation Information

Simplicity Motorized Shadings installed into windows with metal casings may have a reduced radio frequency range, or may not operate at all, depending on the application

Simplicity Motor Hand Held Remotes

IMPORTANT: Simplicity Rechargeable Motorized Shadings are programmed at the factory with the "up and down" limits. The shades are **UNLINKED** from the remote so they are not able to operate during shipping. Each shade should be installed **before** linking it to the remote.

5 Channel Remote

The **5 Channel (5C) remote** can operate up to five shadings simultaneously, individually or in groups.

Simplicity (5C) remotes and holders are black or white in color. The remote comes with a holder which can be mounted to a wall for easy storage. The range of the remote is approximately 80 feet.



6 Channel Timer Remote also available

See page 24 for more information

14 Channel Remote

This remote has 14-channels. Each channel has a setting to operate the bottom rail. The **14 Channel remote** can operate up to fourteen shades individually or 14 groups.

14 Channel remotes and holders are white in color. The remote comes with a holder which can be mounted to a wall for easy storage. The range of the remote is approximately 80 feet.



Please Note:

- Not all motors run at the same rate of speed.
- Simplicity motors have a "Favorites" or "MY" position setting. If the homeowner wants to set several shadings at the same intermediate position, follow instructions provided with installation manual.

Simplicity Battery Operated Motorized Shadings Warranty

Please see page 114 for complete Comfortex warranty information.

NEW Simplicity Bluetooth Motorization

Learn about Simplicity Bluetooth motorization and Comfortex FREE Color Lux Mobile App on page 18.

Sheer Horizontal Window Shadings
7.4V RECHARGEABLE SIMPLICITY HARDWARE SYSTEM

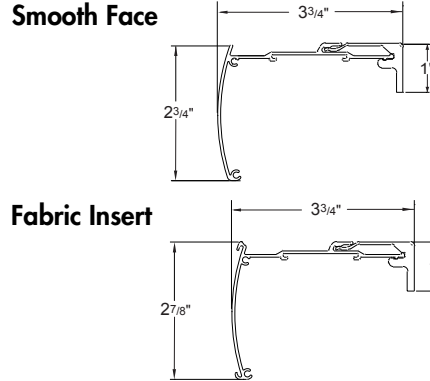

Smooth Face Designer Cassette Head Rail

- Depth of rail and bracket: 3 3/4"
- Height of rail: 2 3/4"
- Height of bracket: 1"

Fabric Insert Designer Cassette Head Rail

- Depth of rail and bracket: 3 3/4"
- Height of rail: 2 7/8"
- Height of bracket: 1"

Hardware Features	
Standard Designer Cassette	Choose from coordinating Fabric Insert or painted Smooth Face rail. Default head rail color is White or Ivory based on shading vane color.
Bottom Rail Color	Color coordinated rail with White/Ivory head rail. Bottom rail will be matched to Oil Rubbed Bronze or Onyx Black when metallic upgrade is selected. With Brushed Nickel Head rail, bottom rail will be coordinated to fabric.
Upgrades	Available for all Designer Cassette Head Rails
Designer Metallic Upgrade (Fabric Insert/Smooth Face)	<ul style="list-style-type: none"> • Oil Rubbed Bronze • Onyx Black • Brushed Nickel
Mounting Dimensions	
Designer Cassette Head Rail	
Minimum Shallow Mount	1"
Minimum Flush Inside Mount (including brackets)	3 3/4"
Minimum Outside Mount	1"
Minimum Side Mount	1 1/4"
Width Side Mount	48" Max width side mount
Finished Dimensions	
Inside Mount	
	<ul style="list-style-type: none"> • Fabric will measure ordered width less: 1" • Head rail* will measure ordered width less: 3/16"
Side (End) Mount	
	<ul style="list-style-type: none"> • Fabric will measure ordered width less: 1 1/2" • Head rail* will measure ordered width less: 11/16"
Outside Mount	
	<ul style="list-style-type: none"> • Fabric will measure ordered width less: 5/8" • Head rail* will measure ordered width plus: 3/16"
Exact (End Cap to End Cap) Mount	
	<ul style="list-style-type: none"> • Fabric will measure ordered width less: 13/16" • Head rail* will measure ordered width
* Head rail measurements include endcaps. Width and length measurements may vary +/- 1/8"	

Please Note: Once ordered and manufactured, the width of the Shangri-La fabric cannot be altered. Comfortex makes deductions to the width depending on the type of mounting indicated. For all mounting types, fabric will measure exactly the length ordered when the vanes are in the closed position.

Sheer Horizontal Window Shadings

7.4V RECHARGEABLE SIMPLICITY HARDWARE SYSTEM

Simplicity Rechargeable Motors

The Rechargeable Simplicity Motor program features an integrated rechargeable lithium ion battery in the motor casing and is fully concealed by the roller tube.

PowerTouch Integrated Rechargeable Surcharges

See page 35 for shading standards and page 37-38 for surcharges and pricing example.

Simplicity Rechargeable Motors

No special installation hardware or wiring requirements are needed to install motorized Shangri-La Shadings with Designer Cassette Head Rail. No external battery wand is required.

Rechargeable Simplicity Motor Batteries

The battery for the integrated rechargeable simplicity motor system is integrated within the motor casing and is fully concealed by the roller tube.

Rechargeable battery comes fully charged from the factory.

Integrated Rechargeable Motor Battery Life

Rechargeable battery is included with the motor.

The average battery charge will last 6-12 months based on an average sized shade raised and lowered once per day. The life of the battery charge will vary based on the type of window covering selected, the size and weight of the window covering and the number of times the shade is operated on a daily basis.



Charging Port

The battery can be recharged up to 500 times. It takes approximately 5 hours to recharge the motor when fully depleted.

Integrated Rechargeable Motor Battery Charger

An 8.4 Volt charger requires a standard power outlet to recharge the battery. The charger must be specified when ordering an Integrated Rechargeable Simplicity Motorized shade. The charger plugs into the charging port of the motor. Sold separately.



The charger is black and comes with a 156" wire. The dimensions are 1" wide x 2½" length x 1¾" deep.

Simplicity Motor Hand Held Remotes

IMPORTANT: Simplicity Rechargeable Motorized Shadings are programmed at the factory with the "up and down" limits. The shades are **UNLINKED** from the remote so they are not able to operate during shipping. Each shade should be installed **before** linking it to the remote.

5 Channel Remote

The **5 Channel (5C) remote** can operate up to five shadings simultaneously, individually or in groups.

Simplicity (5C) remotes and holders are black or white in color. The remote comes with a holder which can be mounted to a wall for easy storage. The range of the remote is approximately 80 feet.



6 Channel Timer Remote also available

See page 24 for more information

14 Channel Remote

This remote has 14-channels. Each channel has a setting to operate the bottom rail. The **14 Channel remote** can operate up to fourteen shades individually or 14 groups.

14 Channel remotes and holders are white in color. The remote comes with a holder which can be mounted to a wall for easy storage. The range of the remote is approximately 80 feet.



Please Note:

- Not all motors run at the same rate of speed.
- Simplicity motors have a "Favorites" or "MY" position setting. If the homeowner wants to set several shadings at the same intermediate position, follow instructions provided with installation manual.
- **WHEN ORDERING THE NEW INTEGRATED RECHARGEABLE, PLEASE ORDER THE NECESSARY BATTERY CHARGER.**

Solar Panel Recharge Option

Plugs in to any Simplicity Rechargeable Remote control shade (does not work with PowerTouch). See page 56.



Dimensions of panel
18½" x 1½"

Sheer Horizontal Window Shadings

7.4V RECHARGEABLE SIMPLICITY HARDWARE SYSTEM

Important Information about Integrated Rechargeable Simplicity Motor Shading Operation and Installation

- Simplicity Motorized Shadings installed into windows with metal casings may have a reduced radio frequency range, or may not operate at all, depending on control.
- Be mindful of when your shade starts to slow down during operation. It is a good indicator the shade needs to be recharged.

Simplicity Battery Operated Motorized Shadings Warranty

Please see page 114 for complete Comfortex warranty information.

Solar Panel Recharge Option

Plugs in to any Simplicity Rechargeable Remote control shade (does not work with PowerTouch)

Provides constant trickle charge to 7.4v Li-Ion Rechargeable battery packs. Will prolong the life of the charge of the 7.4v rechargeable battery packs, and in some applications will maintain charge indefinitely.

Life of charge is subject to application variables such as, size and weight of shade, frequency of use, amount of direct sunlight exposure, etc.



- Solar Panel with Mounting Brackets: \$160.00

Solar panel wire measures 56" in length. Extra wire can be tucked up behind the shade with tie wraps that come with the solar panel.

Solar Recharge Optimum Application

- Full direct sunlight (minimum 2 hours per day) to maintain full charge. Based on one operation cycle per day (one open, one close).
- Excessive duration of cloudy weather will impact the rate of charge.

Solar Panel Mounting

Bottom portion of the bracket may be lowered if needed for more sun exposure. Bracket can be mounted behind or next to shade mounting bracket.

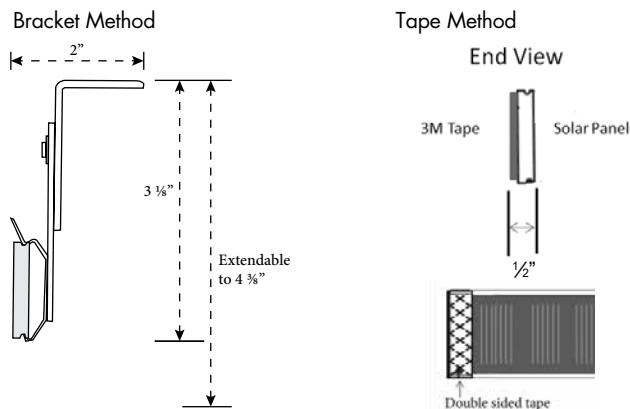

Tape goes on the face (black side) of the panel.

If the solar panel is mounted directly behind the headrail at the top of the window, you need to make sure that the solar panel does not interfere with the shade mounting brackets also. The solar panel can go between brackets spaced apart, or behind brackets if the depth of the window casing allows.

7.4V EZ Charge Extension Wand

Please see page 26 for more information.

12V Simplicity Low Voltage Hardwiring System

Please see page 27 for more information.

Simplicity Smart Controller

Please see page 28 for more information.

Sheer Horizontal Window Shadings

TWO-ON-ONE HARDWARE SYSTEM | DESIGNER CASSETTE HEAD RAIL

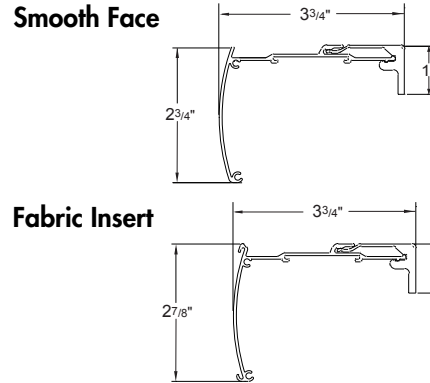

Smooth Face Designer Cassette Head Rail

- Depth of rail and bracket: 3 3/4"
- Height of rail: 2 3/4"
- Height of bracket: 1"

Fabric Insert Designer Cassette Head Rail

- Depth of rail and bracket: 3 3/4"
- Height of rail: 2 7/8"
- Height of bracket: 1"

Hardware Features	
Standard Designer Cassette	Choose from coordinating Fabric Insert or painted Smooth Face rail. Default head rail color is White or Ivory based on shading vane color.
Bottom Rail Color	Color coordinated rail with White/Ivory head rail. Bottom rail will be matched to Oil Rubbed Bronze or Onyx Black when metallic upgrade is selected. With Brushed Nickel Head rail, bottom rail will be coordinated to fabric.
Upgrades	
Designer Metallic Upgrade (Fabric Insert/Smooth Face)	<ul style="list-style-type: none"> • Oil Rubbed Bronze • Onyx Black • Brushed Nickel
Mounting Dimensions	
Finished Dimensions	
Mounting and Finished Dimensions are the same as Cord Loop See Page 44	

Two-On-One Designer Cassette Head Rail

Two-On-One Head Rail shadings are two shadings sharing the same head rail; each shading operates independently.

- Two-On-One Head Rail can be combined with cord loop, PowerTouch Rechargeable, Simplicity Motorization and retractable cord hardware options. Price as two shadings (including upgrades) and add together. Pricing example on page 38.
- Two-On-One not available with cordless.
- Specify shading total width and two individual section widths. **Note:** The two individual sections must add up to the total width.
- Two on One Head Rail Shadings are available with all vane sizes.
- Two on One Head Rail Shadings are available with bead cord or braided cord loop. See page 57 for more information.
- Controls will always be placed to the far left and far right.
- Available in widths up to 140" with Designer Cassette hardware.
- Minimum single section width is 12". Maximum single section width is 102". The center gap between shadings is 3/8".
- Side by side alignment is available if the two panels measure less than 120". Alignment must be specified when the order is placed.
- Shadings over 98" are subject to common carrier surcharge. See page 112 for more information on the freight policy.

Sheer Horizontal Window Shadings

GENERAL INFORMATION

Head Rail Inserts

Fabric head rail inserts are used on Designer Cassette Head Rail Shadings when specified.

We use the light filtering fabric insert strips on all shadings including room darkening colors. The color of the fabric insert coordinates with fabric used on the shading.

Cord Type and Color

White, black or bronze loop cord coordinates with your hardware choice. Bead cord is optional in white, bronze, black or steel. Cord tensioners match your hardware choice (white, black or bronze). Lengths over 6 feet available in white only.

Reverse Roll

The braided cord does not have a reverse roll stop. If a shading with the Designer Cassette hardware is raised above 24" in the reverse roll mode, there is a possibility of the fabric rubbing on the head rail. Comfortex reserves the right NOT to warrant wear and tear of fabric if damaged by roll-up in excess of 24".

Length Considerations with Shangri-La Shadings

Comfortex will fabricate your Shangri-La Window Shading to the length ordered, when the vanes are in the closed position (Figure A).

- When the vanes are rotated to the open position, the shading will become slightly longer.
- When opened on an inside mount, the shading will be slightly longer than ordered length.
- A slight puckering may occur when the vanes are in the open position. Rotating the vanes closed will cause the bottom rail to touch the window sill, before it begins to raise.

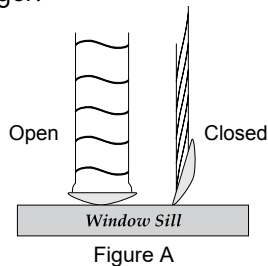

Side By Side Alignment

When Shangri-La Window Shadings are installed side-by-side, vane alignment can be guaranteed within 1/4" only if:

- The shadings are the same color and ordered at the same time.
- The sum total of the widths of all shadings needing alignment is less than 118".

Side-by-side lineup is specified when the order is placed.

Omni-View System

Shangri-La Shadings feature the Omni-View™ Cord System. The Omni-View System provides the ability to manipulate the shading into various viewing positions. There are variations in visibility through the shadings when the vanes are tilted to their maximum open positions. The following five modes can be obtained with standard shading operation when viewing the shading at eye level.

- **Closed top, open bottom:** By partially lowering the shading from the fully raised position, the upper portion of your window will become semi-opaque while allowing a clear view below.
- **Fully private:** When lowered completely, Shangri-La provides complete privacy and softly diffused light.
- **Partially open:** Opening Shangri-La slightly will gradually increase the level of light and allow varying levels of view through.
- **View-through when lowered:** By completely opening the vanes, Shangri-La provides a softened, veiled view to the outside.
- **View-through when raised:** From the open or view-through position, continuing to pull down on the back of the cord will raise the fabric allowing a clear view outside from below, and a veiled view above. This exclusive feature allows Shangri-La to be raised up to 24" in this mode.
- Comfortex recommends that you **do not** raise the shading more than 24" off the sill in the view-through when raised mode. Refer to warranty section below for more information.
- Omni-View is only available with Shangri-La Shadings built with braided cord loop.

Cord Information For Shangri-La Shadings

A braided cord loop is used to raise and lower the shading. White, black or bronze loop cord matches your hardware choice. Cord tensioner will match the hardware color.

Bead cord is available in black, white, bronze, nickel and steel. Lengths over 6 feet available in white only.

The cord loop will measure the length indicated below unless otherwise specified.

Shade Length	Standard Loop
16" to 26 ⁷ / ₈ "	1' (12")
27" to 39 ⁷ / ₈ "	2' (24")
40" to 59 ⁷ / ₈ "	3' (36")
60" to 83 ⁷ / ₈ "	4' (48")
84" to 107 ⁷ / ₈ "	5' (60")
108" and greater	6' (72")

Maximum cord length is 15 feet. Polyester cord can be ordered in custom lengths in 1 foot increments only.

Braided Cord Loop Warranty Information

The shadings built with a braided cord loop do not have a reverse roll stop. If a shading is raised above 24" in the reverse roll mode, there is a possibility of the fabric rubbing on the head rail. Comfortex reserves the right NOT to warrant wear and tear of fabric if damaged by roll-up in excess of 24".

Sheer Horizontal Window Shadings

GENERAL INFORMATION

Certified Fabrics | GREENGUARD® Fabrics

GREENGUARD Environmental Institute has established performance based standards to define goods with low chemical and particle emissions for use indoors.

The Shangri-La fabrics have the passed GREENGUARD Indoor Air Quality Certified® certification program for low emitting interior building materials, furnishings, and finish systems.

Flame Resistance

Shangri-La fabric may be processed with a topical treatment to resist flames and adhere to strict flammability codes. For more information, contact Customer Service at (800) 843-4151.

UV Protection

Ultraviolet light, entering the home as sunlight, damages furnishings. In time it fades wood floors, furniture, upholstery, draperies, carpeting and artwork. Prolonged exposure to sunlight causes natural, undyed fabrics to turn yellow, weakening their fibers and making them look old and worn prematurely.

The right window covering can be very effective in blocking ultraviolet rays. Such effectiveness is measured in terms of a "% UV blockage" rating. The higher the rating, the greater the UV protection.

Shangri-La fabrics have the following UV Protection ratings:

Light Filtering Fabrics	Open Vanes	87%
Room Darkening Fabric	Open Vanes	88%
All Fabrics	Closed Vanes	99%

Vane Closure

Shangri-La vanes are not designed to close tightly. The inherent nature of the fabric will cause a slight increase in the distance from the front sheer to back sheer as you move further down the shading. These vanes do not form a perfect seal against light leakage which is most visible toward the bottom of the shading. Vane overlap ensures that privacy is not compromised.

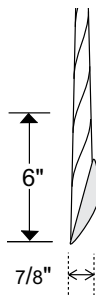

Vane closure is measured as the distance between the front and rear fabric sheers 6" up from the lowest point of the bottom rail, with the shading fully lowered and the vanes closed.

On light filtering fabrics, the maximum distance from the front sheer to the back sheer when closed is equal to or less than 5/8" for shadings under 60" and 7/8" for shadings longer than 60". On room darkening fabrics, the distance is 5/8" regardless of shading length.

On all 3" fabrics, the distance is equal to or less than 1".

Vane Opening and Visibility

Vaness on the three styles of Shangri-La fabrics open to slightly different degrees. Consequently, there are variations in visibility through the shadings when the vanes are tilted to their maximum open positions. The variations among the products are shown in the below illustration when looking through the shading 1/4 of the way up from the bottom.

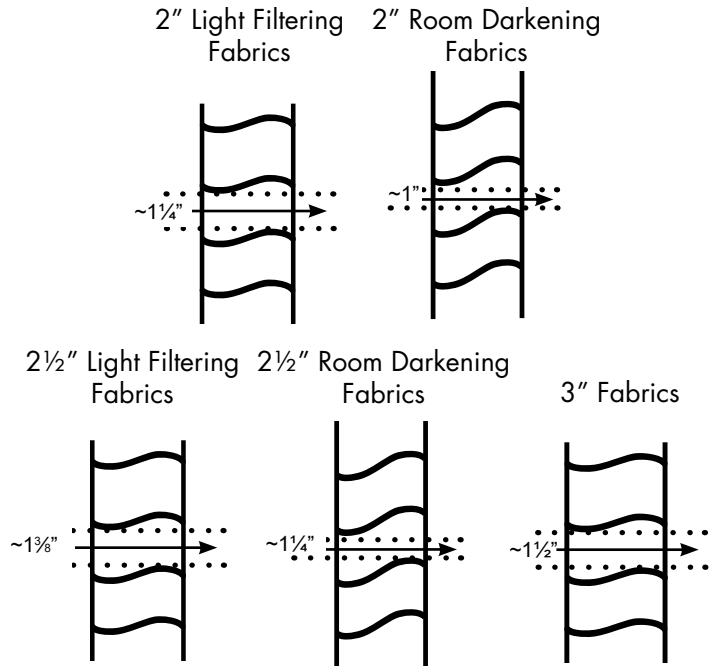

Magnetic Hold-Down Brackets

Optional magnetic hold-down brackets secure the bottom of the shading to prevent swaying. Please specify when ordering.

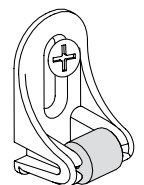

Extension Brackets

Extension or "L" brackets are available to project the back of the shading from the mounting surface. The extension brackets for Designer Cassette head rail projects it 3".

Spacer Blocks

Spacer blocks project the shading 3/8" from the mounting surface. Use spacer blocks to obtain clearance when obstructions, such as window cranks or door handles, obstruct the movement of the shading.

Leveling Shangri-La Sheer Shadings

Shangri-La Window Shadings are leveled and weighted in the factory. When installed level, the fabric will not skew when raised. If the head rail is not installed level, skewing can occur that can damage the edge of the fabric. Be sure to follow the installation instructions carefully to ensure correct and balanced operation.

Sheer Horizontal Window Shadings

GENERAL INFORMATION

Skew Adjusting Bottom Rail

After installation, windows that are not square and level may cause the shadings to shift to one side as it rolls up, requiring adjustment of the bottom rail. If the brackets are not level it may be necessary to adjust the bottom rail weight.

- To access the bottom rail weight, release the weight clip on the bottom rail by using a flat blade screwdriver. Insert it into the weight clip in the bottom rail and turn clockwise.
- Move the weight in 1" increments toward the side where the fabric is gathering.
- Secure the weight clips in position by turning them counterclockwise after making the adjustment.

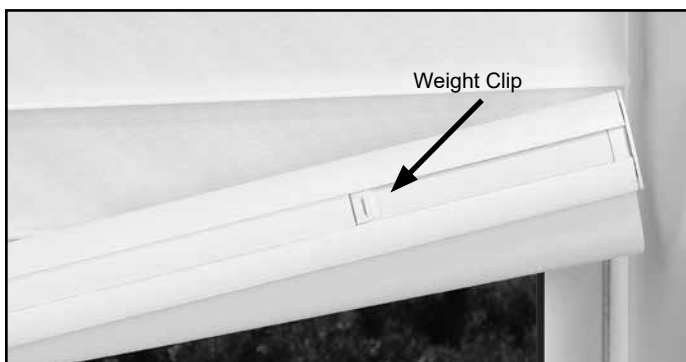

Highlights Cornice Valance

Please see page 108 for more information.

Cleaning And Care

Please see page 109 for more information.

Measuring Instructions

Please see page 110 for more information.

Child Safety

Please see page 111 for child safety information.

7.4V EZ Charge Extension Wand

Please see page 26 for more information.

Low Voltage Hardwiring

Please see page 27 for more information.

Simplicity Smart Controller

Please see page 28 for child safety information.

PARADISE™ SHEER SHADINGS



- Paradise Sheer Shadings are a window shading of unique beauty and performance for the finishing touch to a beautiful window and room.
- Horizontal fabric vanes float between two layers of soft, knitted fabric sheers to soften your view outside.
- Features both light filtering and room darkening fabrics, these fabrics filter out up to 88% of harmful UV rays when open and 99% when closed.
- Paradise Sheer Shadings are the perfect way to provide the privacy and light control that any home needs.
- Vanes glide from open to closed to out of sight with elegant hardware.
- A weight system in the bottom rail allows for on-the-spot skew adjustment for proper performance and a balanced appearance in the window.
- The sophisticated array of Paradise Sheer Shadings colors is designed to flatter your decor.
- Easy to install hardware and brackets allow for effortless installations and easy removal for cleaning.
- Paradise Sheer Shadings may be ultrasonically or traditionally cleaned to stay bright and beautiful.
- A Limited Lifetime Warranty serves as a commitment to your satisfaction.

PARADISE SHEER SHADING

Expanded Paradise Color Offering

Paradise Sheer Shadings utilize Shangri-La Sheer Horizontal Shadings pricing and colors. Paradise 2", 2½" & 3" vanes offer sophistication without distracting from other fabrics or furnishings. Elegant, yet casual, Paradise shades enrich the ambiance of any room with light filtering or room darkening options. Paradise Sheer shadings are offered in all the colors available in the Shangri-La collection with the exception of 9 colors.

[Click to View Available Colors](#)

NOT AVAILABLE	NUMBER	NAME
2" Vane	3019	Mocha Aura
	3099	Black Aura
2½" Vane	5203	Ecru
	7211	Truffle
3" Vane	31070	Feather Gray
	33019	Mocha Aura
	33099	Black Aura
	34099	Black Aura
	34042	Willow Aura

Paradise™ Sheer Shadings
SIZE STANDARDS



				Paradise Sheer Shading			Rechargeable Motorization		
				Cord Loop	Cordless	Retractable Cord	Simplicity	PowerTouch	
LIGHT FILTERING ROOM DARKENING		Minimum Width		12"	18"	12"	21"	21"	
		Minimum Length		16"	16"	16"	12"	12"	
				Paradise Sheer Shading			Rechargeable Motorization		
Light Filtering	Price Group	Page		Cord Loop	Cordless	Retractable Cord	Simplicity	PowerTouch	
2" Vanes	15	63	Maximum Width & Length	120"* x 120"	84"* x 84"	120"* x 120"	120"* x 96" 60 sq ft	120"* x 96" 60 sq ft	
2½" Vanes	17	64							
3" Vanes	19	65							
				Paradise Sheer Shading			Rechargeable Motorization		
Room Darkening	Price Group	Page		Cord Loop	Cordless	Retractable Cord	Simplicity	PowerTouch	
2" Vanes	16	63	Maximum Width & Length	120"* x 102"	84"* x 84"	120"* x 102"	120"* x 84" 50 sq ft	120"* x 84" 50 sq ft	
2½" Vanes	18	64							
3" Vanes	20	65							
				Cord Loop	Cordless	Retractable Cord	Simplicity Rechargeable	PowerTouch Rechargeable	
More Information On Page				Page 66	Page 71	Page 74	Page 79	Page 76	

Please Note: Once ordered and manufactured, the width of the Paradise fabric cannot be altered. Comfortex makes deductions to the width depending on the type of mounting indicated. For all mounting types, fabric will measure exactly the length ordered when the vanes are in the closed position.

Tilt only shadings 6" to 11 7/8" (Standard only - No charge)

*Head rail measurements include end caps.

LIFT SYSTEM		ADD	
Cord Loop		Included	
Cordless or Retractable Cord Shading		\$106	
ADDITIONAL OPTIONS	UPGRADES	ADD	
Head Rail Style	Choice of Color Coordinated hardware or Coordinating Fabric Insert Strip	No Charge - Standard	
Two-One-One Head Rail	Cord Loop or Retractable Cord Only	Price as two shadings and add together.	
MOTORIZED	UPGRADES	ADD	
Simplicity Bluetooth Motorization	Bluetooth Motors work with Remote Control	Standard	For More Information Page 18
	Color Lux Bluetooth Mobile Application	FREE	
7.4V Rechargeable PowerTouch Motorization System	Rechargeable with Integrated Battery Pack	\$188	For More Information Page 76
	Plug-In Charger for Rechargeable Li-Ion	\$44	
7.4V Rechargeable Simplicity Motorization System	Motor and Integrated Battery Pack	\$509	For More Information Page 79
	Simplicity 5 Channel Remote	\$65	
	Simplicity 14 Channel Remote	\$107	
	Plug-In Charger for Rechargeable Li-Ion	\$44	
	7.4v Solar Panel	\$168	
Simplicity Smart Controller System	NEO Controller	\$536	For More Information Page 28
	NEO Application for Mobile Devices	FREE	

Shadings wider than 96": Shadings over 96" in width may require additional fabrication and delivery time.

Paradise™ Sheer Shadings
PRICING

2" Light Filtering Vanes

PRICE GROUP 15
Cord Loop

		Width In Inches												
		24	30	36	42	48	54	60	66	72	84	96	108	120
Length In Inches	36	662	743	832	908	994	1082	1161	1247	1458	1637	1807	2192	2581
	42	698	786	874	971	1061	1159	1247	1336	1558	1750	1931	2354	2777
	48	739	834	935	1028	1127	1227	1333	1438	1661	1861	2060	2522	2980
	54	770	873	982	1089	1200	1306	1423	1541	1761	1971	2205	2761	3314
	60	805	923	1033	1148	1261	1391	1510	1638	1853	2097	2350	2949	3549
	66	841	966	1087	1210	1336	1471	1612	1743	1955	2229	2499	3136	3771
	72	874	1009	1141	1272	1412	1558	1700	1845	2060	2354	2646	3341	4033
	78	901	1045	1181	1327	1475	1628	1776	1932	2158	2475	2777	3510	4240
	84	938	1087	1230	1396	1551	1711	1877	2039	2270	2607	2928	3685	4449
	90	978	1127	1287	1456	1626	1805	1966	2139	2380	2731	3073	3890	4705
	96	1014	1176	1339	1522	1700	1878	2055	2235	2490	2858	3219	4085	4948
	102	1162	1344	1530	1730	1912	2086	2331	2559	2735	3112	3471	4198	5055
	108	1223	1414	1612	1821	2007	2201	2451	2695	2883	3270	3654	4420	5183
	114	1297	1500	1709	1931	2139	2339	2600	2857	3058	3471	3873	4688	5504
120	1396	1606	1835	2068	2281	2499	2778	3058	3271	3716	4147	5018	5884	

2" Room Darkening Vanes

PRICE GROUP 16
Cord Loop

		Width In Inches												
		24	30	36	42	48	54	60	66	72	84	96	108	120
Length In Inches	36	729	818	915	1000	1094	1190	1278	1371	1604	1801	1988	2412	2839
	42	768	866	961	1069	1167	1276	1371	1470	1714	1926	2124	2590	3055
	48	813	917	1028	1131	1241	1351	1467	1583	1828	2047	2266	2774	3279
	54	847	960	1081	1198	1321	1436	1566	1696	1937	2169	2425	3037	3646
	60	886	1016	1137	1263	1388	1530	1662	1802	2039	2307	2586	3245	3904
	66	925	1062	1196	1331	1470	1619	1774	1918	2151	2453	2750	3450	4149
	72	961	1110	1255	1399	1553	1714	1870	2031	2266	2590	2910	3676	4437
	78	991	1150	1299	1460	1624	1791	1954	2125	2375	2723	3055	3861	4664
	84	1032	1196	1354	1536	1706	1883	2066	2243	2497	2869	3221	4054	4894
	90	1076	1241	1416	1602	1789	1986	2162	2353	2618	3005	3381	4279	5175
	96	1116	1294	1473	1674	1870	2067	2261	2458	2739	3144	3542	4494	5443
	102	1279	1479	1684	1903	2104	2295	2565	2815	3009	3424	3818	4618	5560

PARADISE SHEER SHADING

LIFT SYSTEM	ADD
Cord Loop	Included
Cordless	\$106
Retractable Cord	\$106
Motorization	Pg 50

DESIGNER UPGRADE OPTIONS	UPGRADES
Add to Any Lift System Upgrade (Chart to the left)	Highlights Valance See Page 108 For More Information

ADDITIONAL OPTIONS	UPGRADES	ADD	MORE INFO
Two-On-One Head Rail	Cord Loop or Retractable Cord Only	Price as two shadings and add together.	
MOTORIZATION	For motorization surcharges and options refer to page 62.		Pg 62

Shadings wider than 96": Shadings over 96" in width may require additional fabrication and delivery time.

Paradise™ Sheer Shadings
PRICING

2½" Light Filtering Vanes

PRICE GROUP 17
Cord Loop

		Width In Inches												
		24	30	36	42	48	54	60	66	72	84	96	108	120
Length In Inches	36	696	781	874	954	1045	1137	1220	1310	1531	1720	1898	2303	2710
	42	733	827	918	1020	1115	1218	1310	1403	1636	1838	2028	2472	2916
	48	776	876	982	1080	1184	1289	1400	1510	1744	1954	2163	2649	3130
	54	809	917	1032	1144	1261	1371	1495	1619	1849	2070	2315	2899	3480
	60	846	970	1085	1206	1325	1461	1587	1721	1946	2202	2468	3098	3727
	66	883	1014	1142	1270	1403	1545	1694	1831	2053	2342	2625	3293	3961
	72	918	1059	1198	1335	1483	1636	1785	1938	2163	2472	2778	3509	4235
	78	946	1097	1241	1394	1550	1709	1866	2029	2266	2599	2916	3686	4452
	84	985	1142	1292	1466	1629	1798	1972	2141	2384	2738	3075	3869	4672
	90	1027	1184	1352	1529	1707	1896	2065	2246	2499	2868	3227	4084	4940
	96	1066	1235	1406	1598	1785	1973	2158	2347	2615	3001	3381	4290	5196
	102	1221	1412	1607	1816	2008	2191	2449	2688	2872	3269	3645	4408	5308
108	1285	1485	1694	1912	2108	2311	2573	2830	3028	3433	3837	4642	5443	
114	1362	1575	1795	2028	2246	2456	2731	3000	3211	3645	4067	4923	5780	
120	1466	1687	1928	2172	2395	2625	2917	3211	3435	3902	4355	5269	6178	

2½" Room Darkening Vanes

PRICE GROUP 18
Cord Loop

		Width In Inches												
		24	30	36	42	48	54	60	66	72	84	96	108	120
Length In Inches	36	766	860	961	1050	1150	1251	1343	1441	1685	1892	2088	2533	2982
	42	807	910	1011	1122	1227	1341	1441	1544	1800	2022	2230	2720	3209
	48	854	964	1081	1188	1302	1419	1540	1662	1919	2150	2380	2914	3443
	54	890	1009	1136	1258	1388	1509	1645	1781	2035	2277	2547	3189	3828
	60	932	1068	1194	1326	1458	1607	1745	1893	2141	2422	2716	3408	4100
	66	972	1116	1256	1398	1544	1700	1864	2014	2259	2577	2888	3623	4357
	72	1011	1165	1319	1469	1631	1800	1965	2133	2380	2720	3057	3860	4659
	78	1041	1208	1365	1534	1705	1880	2053	2231	2493	2860	3209	4055	4898
	84	1084	1256	1422	1613	1793	1978	2170	2355	2623	3012	3383	4256	5139
	90	1130	1302	1488	1682	1878	2085	2272	2470	2750	3155	3551	4493	5435
	96	1173	1359	1548	1759	1965	2171	2375	2582	2876	3302	3720	4720	5716
	102	1344	1553	1768	1999	2209	2411	2694	2957	3160	3596	4009	4849	5840

PARADISE SHEER SHADING

LIFT SYSTEM	ADD
Cord Loop	Included
Cordless	\$106
Retractable Cord	\$106
Motorization	Pg 62

DESIGNER UPGRADE OPTIONS	UPGRADES
Add to Any Lift System Upgrade (Chart to the left)	Highlights Valance See Page 108 For More Information

ADDITIONAL OPTIONS	UPGRADES	ADD	MORE INFO
Two-On-One Head Rail	Cord Loop or Retractable Cord Only	Price as two shadings and add together.	
MOTORIZATION			Pg 62
For motorization surcharges and options refer to page 62.			

Shadings wider than 96": Shadings over 96" in width may require additional fabrication and delivery time.

Paradise™ Sheer Shadings
PRICING

3" Light Filtering Vanes

PRICE GROUP 19
Cord Loop

		Width In Inches												
		24	30	36	42	48	54	60	66	72	84	96	108	120
Length In Inches	36	729	818	915	1000	1094	1190	1278	1371	1604	1801	1988	2412	2839
	42	768	866	961	1069	1167	1276	1371	1470	1714	1926	2124	2590	3055
	48	813	917	1028	1131	1241	1351	1467	1583	1828	2047	2266	2774	3279
	54	847	960	1081	1198	1321	1436	1566	1696	1937	2169	2425	3037	3646
	60	886	1016	1137	1263	1388	1530	1662	1802	2039	2307	2586	3245	3904
	66	925	1062	1196	1331	1470	1619	1774	1918	2151	2453	2750	3450	4149
	72	961	1110	1255	1399	1553	1714	1870	2031	2266	2590	2910	3676	4437
	78	991	1150	1299	1460	1624	1791	1954	2125	2375	2723	3055	3861	4664
	84	1032	1196	1354	1536	1706	1883	2066	2243	2497	2869	3221	4054	4894
	90	1076	1241	1416	1602	1789	1986	2162	2353	2618	3005	3381	4279	5175
	96	1116	1294	1473	1674	1870	2067	2261	2458	2739	3144	3542	4494	5443
	102	1279	1479	1684	1903	2104	2295	2565	2815	3009	3424	3818	4618	5560
108	1346	1556	1774	2003	2208	2421	2696	2965	3172	3597	4020	4863	5703	
114	1427	1651	1880	2124	2353	2572	2861	3143	3363	3818	4261	5158	6055	
120	1536	1767	2019	2275	2510	2750	3057	3363	3598	4088	4562	5520	6473	

3" Room Darkening Vanes

PRICE GROUP 20
Cord Loop

		Width In Inches												
		24	30	36	42	48	54	60	66	72	84	96	108	120
Length In Inches	36	802	901	1007	1100	1205	1310	1405	1509	1765	1981	2187	2654	3123
	42	845	952	1058	1176	1285	1403	1509	1618	1886	2118	2338	2849	3361
	48	895	1009	1131	1245	1365	1487	1615	1741	2011	2252	2493	3052	3608
	54	933	1057	1189	1319	1454	1581	1723	1866	2131	2386	2668	3341	4010
	60	975	1118	1251	1390	1527	1684	1829	1982	2243	2537	2844	3569	4295
	66	1018	1170	1317	1465	1618	1781	1952	2111	2366	2699	3025	3795	4564
	72	1058	1221	1381	1539	1708	1886	2057	2235	2493	2849	3202	4043	4881
	78	1091	1265	1430	1606	1787	1970	2150	2339	2613	2996	3361	4247	5131
	84	1136	1317	1490	1691	1877	2072	2273	2467	2748	3156	3544	4459	5384
	90	1184	1365	1558	1763	1968	2185	2379	2589	2880	3306	3720	4708	5693
	96	1228	1424	1621	1842	2057	2274	2488	2704	3013	3459	3896	4944	5988
	102	1407	1627	1852	2093	2315	2525	2822	3098	3311	3767	4200	5080	6117

LIFT SYSTEM	UPGRADES	ADD
Cord Loop	Bottom Up	Included
Cordless	Bottom Up	\$106
Retractable Cord	Bottom Up	\$106
Motorization	Bottom Up	Pg 62

DESIGNER UPGRADE OPTIONS	UPGRADES
Add to Any Lift System Upgrade (Chart to the left)	Highlights Valance See Page 108 For More Information

ADDITIONAL OPTIONS	UPGRADES	ADD	MORE INFO
Two-On-One Head Rail	Cord Loop or Retractable Cord Only	Price as two shadings and add together.	
MOTORIZATION			Pg 62

For motorization surcharges and options refer to page 62.

Shadings wider than 96": Shadings over 96" in width may require additional fabrication and delivery time.

Paradise™ Sheer Shadings
CORD LOOP HARDWARE SYSTEM

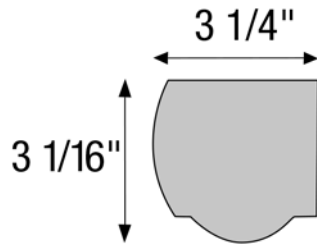

Cord Loop Rail Dimensions

- Depth of cassette: 3 1/4"
- Height of cassette: 3 1/16"

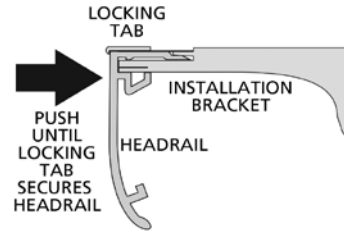

Hardware Features	
Hardware colors for all Paradise fabrics	Choose from coordinating Fabric Insert or painted Smooth Face rail. Painted aluminum cassette head rail will be pre-coordinated to the fabric selection.
Cord	A color coordinated nylon cord is standard.
Upgrades- No Charge	
Head Rail Insert	Fabric head rail fabric inserts are optional. The color of the fabric insert coordinates with fabric used on the shading and is not necessarily an exact match to the vane material. Color Coordinated endcaps.

Mounting Dimensions	Cord Loop Hardware System
Minimum Depth Inside Mount	1"
Minimum Depth Flush Inside Mount	3 3/8"
Minimum Rear Fabric Clearance Inside Mount	1/8"
Minimum Surface Height Outside Mount	1"
Outside Mount Recommended Overlap Per Side	3"
Minimum Rear Fabric Clearance Outside Mount	1/8"

Finished Dimensions	
Inside Mount	
	<ul style="list-style-type: none"> • Fabric will measure ordered width less: 1" • Head rail* will measure ordered width less: 1/8"*
Outside Mount	
	<ul style="list-style-type: none"> • Fabric will measure ordered width minus: 3/4" • Head rail will measure ordered width • Fabric height will measure ordered length less: 1/8"

* Head rail measurements include endcaps.

Please Note: Due to variations in fabric weave and environmental conditions, the finished dimensions for both width and length may vary, plus or minus 1/8" from your order measurements.

PARADISE SHEER SHADING

Paradise™ Sheer Shadings CORD LOOP HARDWARE SYSTEM

Applications

- Standard Rectangular

Cord Information

A nylon cord loop is used to raise and lower Paradise Sheer Shadings.

Select desired control side of the shade when ordering.

Shade Height	Loop Drop
16" to 26 ⁷ / ₈ "	12" loop
27" to 39 ⁷ / ₈ "	24" loop
40" to 59 ⁷ / ₈ "	36" loop
60" to 83 ⁷ / ₈ "	48" loop
84" to 107 ⁷ / ₈ "	60" loop
108" to 120"	72" loop

Optional Cord Drops (White Cord Only)

Cord Drop	Increments
6' to 12'	6" Increments
12' to 16'	12" Increments

Note: 18" white only cords available upon request

Length Considerations

Paradise Sheer Shadings are fabricated to the exact length ordered, when the vanes are in the closed position (Figure A).

- When the vanes are rotated to the open position, the shading will become slightly longer.
- When opened on an inside mount, the shading will be slightly longer than ordered length.
- A slight puckering may occur when the vanes are in the open position. Rotating the vanes closed will cause the bottom rail to touch the window sill, before it begins to raise.

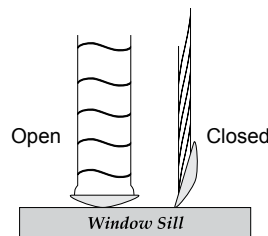

Figure A

Side By Side Alignment

When Paradise Sheer Shadings are installed side-by-side, vane alignment can be guaranteed within 1/4" only if:

- The shadings are the same color and ordered at the same time.
- The sum total of the widths of all shadings needing alignment is less than 102".
- Side-by-side lineup is specified when the order is placed.

Vane Opening

Vane opening is the amount of unobstructed visibility between fully open vanes when looking through the shading at eye level. Vane opening for shadings is up to 1 3/8"

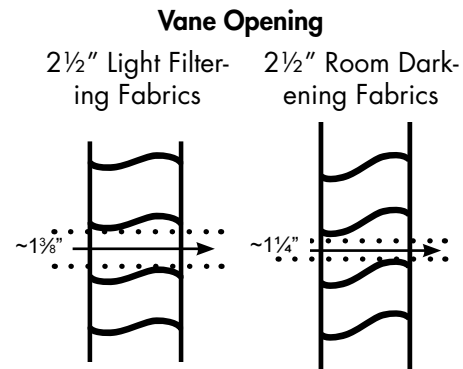

Vane Closure (Figure B)

Paradise vanes are not designed to close tightly. The inherent nature of the fabric will cause a slight increase in the distance from the front sheer to back sheer as you move further down the shading. These vanes do not form a perfect seal against light leakage which is most visible toward the bottom of the shading. Vane overlap ensures that privacy is not compromised.

Vane closure is measured as the distance between the front and rear fabric sheers 6" up from the lowest point of the bottom rail, with the shading fully lowered and the vanes closed.

On light filtering fabrics, the maximum distance from the front sheer to the back sheer when closed is equal to or less than 5/8" for shadings under 60" and 7/8" for shadings longer than 60". On room darkening fabrics, the distance is 5/8" regardless of shading length.

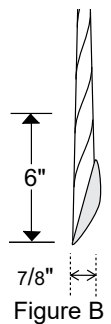

Figure B

Paradise™ Sheer Shadings

CORD LOOP HARDWARE SYSTEM

Standard Operation

Refer to illustration below.

- Illustration 1: The shading is in the fully raised position.
- Illustration 2: Pull down on rear half of nylon cord loop to lower shading and open fabric vanes.
- Illustration 3: Pull down on front half of nylon cord loop to close vanes and raise shading

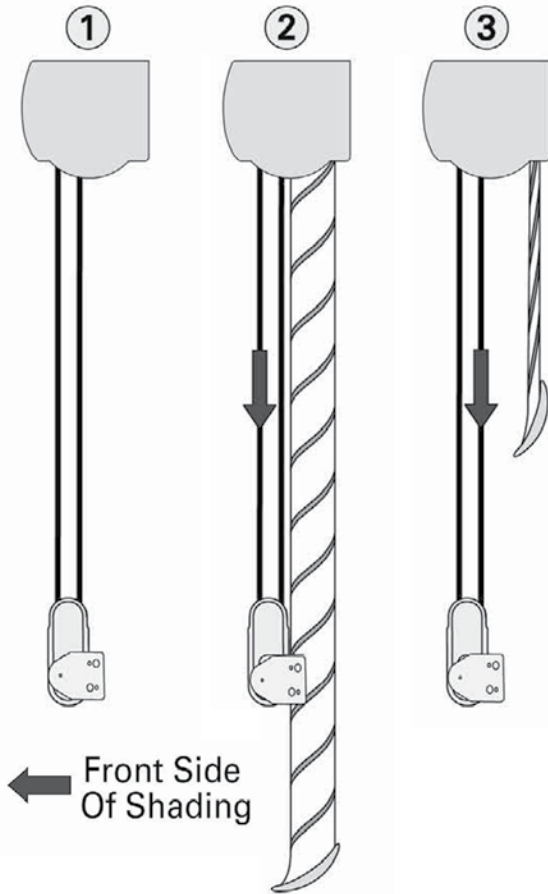

Shading Adjustment

After installation, windows that are not square and level may cause the shadings to shift to one side as it rolls up, requiring adjustment of the bottom rail. If the brackets are not level it may be necessary to adjust the bottom rail weight.

- To access the bottom rail weight, release the weight clip on the bottom rail by inserting a flat blade screwdriver into the weight clip in the bottom rail and turn clockwise.
- Move the weight in 1" increments toward the side where the fabric is gathering.
- Secure the weight clips in position by turning them counterclockwise after making the adjustment.

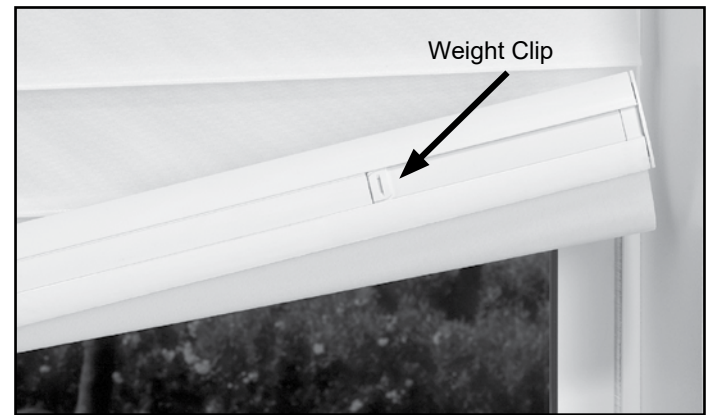

UV Protection

Ultraviolet light, entering the home as sunlight, damages furnishings. In time it fades wood floors, furniture, upholstery, draperies, carpeting and artwork. Prolonged exposure to sunlight causes natural, undyed fabrics to turn yellow, weakening their fibers and making them look old and worn prematurely.

The right window covering can be very effective in blocking ultraviolet rays. Such effectiveness is measured in terms of a "% UV blockage" rating. The higher the rating, the greater the UV protection.

Paradise Sheer Shadings fabrics have the following UV Protection ratings:

Light Filtering Fabrics	Open Vanes	88%
Room Darkening Fabric	Open Vanes	88%
All Fabrics	Closed Vanes	99%

Omni-View System

The Omni-View System is exclusive to Shangri-La Sheer Horizontal Shadings and Color Lux Sheer Shadings. Omni-View is not available on Paradise Sheer Shadings.

Light Control

With the shading in the fully lowered position, the nylon cord loop is used to adjust the fabric vanes from open to closed, and anywhere in between.

Please Note: The degree of maximum vane closure varies slightly from the top to the bottom of the shading.

Paradise™ Sheer Shadings

CORD LOOP HARDWARE SYSTEM

Magnetic Hold-Down Brackets

Optional magnetic hold-down brackets secure the bottom of the shading to prevent swaying. Please specify when ordering.

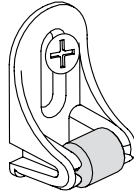

Measuring Instructions

See page 110 for measuring instructions.

Child Safety

See page 111 for child safety information.

Extension Brackets

Extension or "L" brackets are available to project the back of the shading from the mounting surface. Brackets will project 2½".

Limited Lifetime Warranty

See page 113 for warranty information.

Spacer Blocks

Spacer blocks project the shading ¾" from the mounting surface. Use spacer blocks to obtain clearance when obstructions, such as window cranks or door handles, obstruct the movement of the shading.

Paradise™ Sheer Shadings
CORD LOOP HARDWARE SYSTEM

PARADISE SHEER SHADING

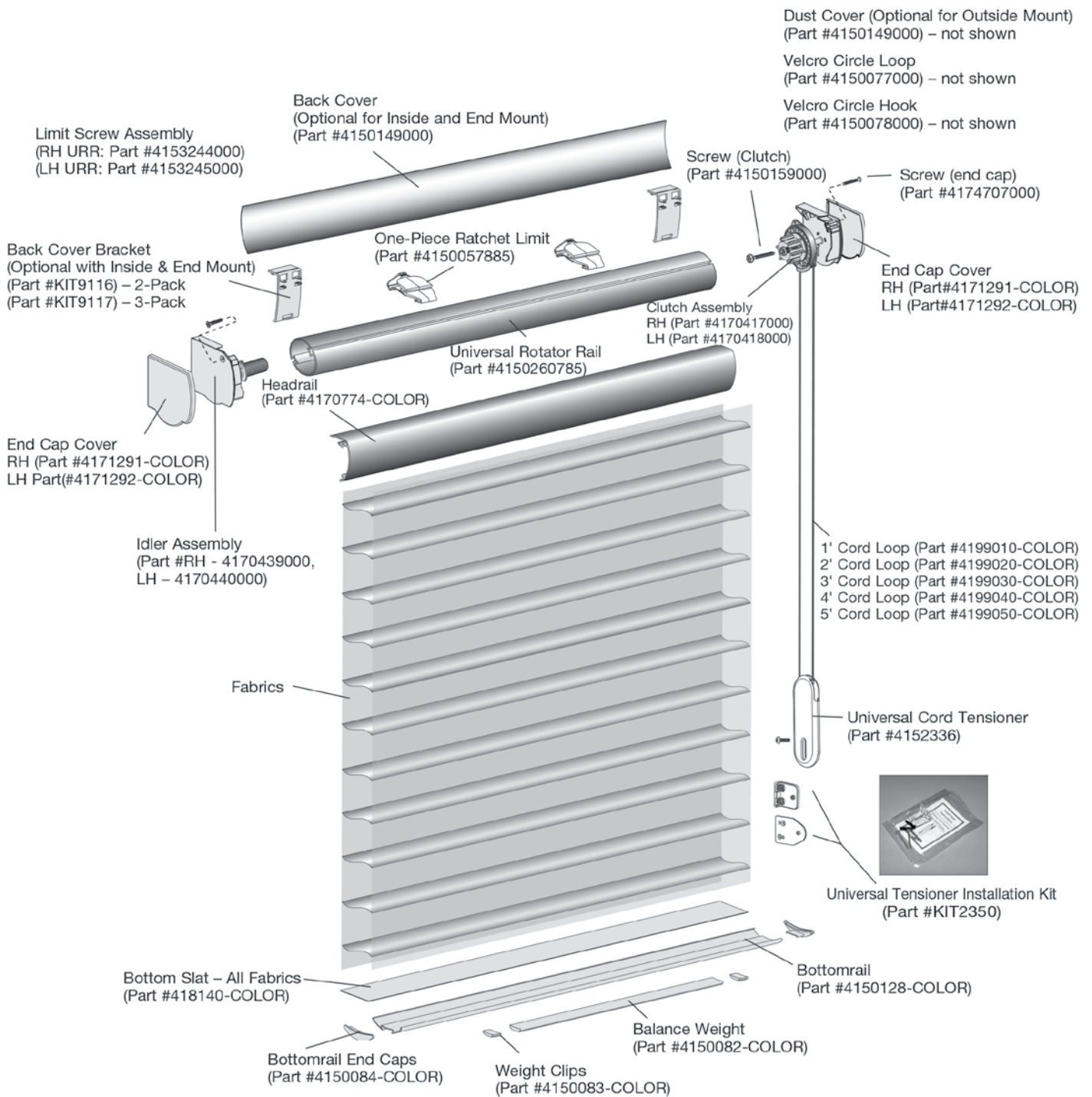

MAGNETIC HOLD-DOWN
(PART #KIT9108)



INSTALLATION
BRACKET PAIR
(PART #KIT9109)

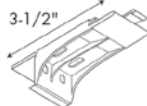

BRACKETS-3
(PART #KIT9110)

BACK COVER
BRACKET
(Part #KIT9116) – 2-Pack
(Part #KIT9117) – 3-Pack



INSIDE MOUNT ONLY
(OPTIONAL)

BACK
COVER
(PART #4150149000)



1/2" SPACER BLOCK
(PART #KIT2011) – 2 PACK
(PART #KIT2012) – 3 PACK



OUTSIDE MOUNT ONLY
(OPTIONAL)

EXTENSION
BRACKET
(Part #KIT2013) – 2-Pack
(Part #KIT2014) – 3-Pack



Paradise™ Sheer Shadings
CORDLESS HARDWARE SYSTEM

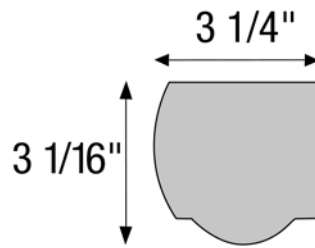
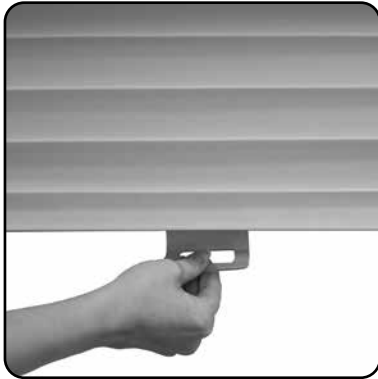

Cordless Rail Dimensions

- Depth of cassette: 3 1/4"
- Height of cassette: 3 1/16"

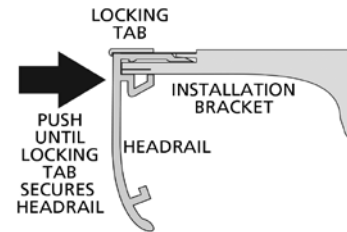

Hardware Features	
Hardware colors for all Paradise fabrics	Choose from coordinating Fabric Insert or painted Smooth Face rail. Painted aluminum cassette head rail will be pre-coordinated to the fabric selection.
Handle	Clear plastic handle.
Upgrades- No Charge	
Head Rail Insert	Fabric head rail fabric inserts are optional. The color of the fabric insert coordinates with fabric used on the shading and is not necessarily an exact match to the vane material. Color Coordinated endcaps.

Mounting Dimensions	Cordless Hardware System
Minimum Depth Inside Mount	1"
Minimum Depth Flush Inside Mount	3 3/8"
Minimum Rear Fabric Clearance Inside Mount	1/8"
Minimum Surface Height Outside Mount	1"
Outside Mount Recommended Overlap Per Side	3"
Minimum Rear Fabric Clearance Outside Mount	1/8"

Finished Dimensions	
Inside Mount	
	<ul style="list-style-type: none"> • Fabric will measure ordered width less: 1" • Head rail* will measure ordered width less: 1/8"*
Outside Mount	
	<ul style="list-style-type: none"> • Fabric will measure ordered width minus: 3/4" • Head rail will measure ordered width • Fabric height will measure ordered length less: 1/8"

* Head rail measurements include endcaps.
Please Note: Due to variations in fabric weave and environmental conditions, the finished dimensions for both width and length may vary, plus or minus 1/8" from your order measurements.

PARADISE SHEER SHADING

Paradise™ Sheer Shadings CORDLESS HARDWARE SYSTEM

Applications

- Standard Rectangular

Length Considerations

Paradise Sheer Shadings are fabricated to the exact length ordered, when the vanes are in the closed position (Figure A).

- When the vanes are rotated to the open position, the shading will become slightly longer.
- When opened on an inside mount, the shading will be slightly longer than ordered length.
- A slight puckering may occur when the vanes are in the open position. Rotating the vanes closed will cause the bottom rail to touch the window sill, before it begins to raise.

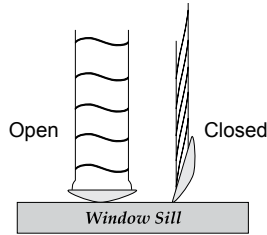

Figure A

Vane Closure (Figure B)

Paradise vanes are not designed to close tightly. The inherent nature of the fabric will cause a slight increase in the distance from the front sheer to back sheer as you move further down the shading. These vanes do not form a perfect seal against light leakage which is most visible toward the bottom of the shading. Vane overlap ensures that privacy is not compromised.

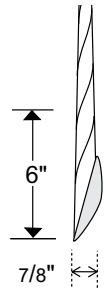

Figure B

Vane closure is measured as the distance between the front and rear fabric sheers 6" up from the lowest point of the bottom rail, with the shading fully lowered and the vanes closed.

On light filtering fabrics, the maximum distance from the front sheer to the back sheer when closed is equal to or less than 5/8" for shadings under 60" and 7/8" for shadings longer than 60". On room darkening fabrics, the distance is 5/8" regardless of shading length.



Bottom Rail with Vanes Closed



Bottom Rail with Vanes Opened

Side By Side Alignment

When Paradise Sheer Shadings are installed side-by-side, vane alignment can be guaranteed within 1/4" only if:

- The shadings are the same color and ordered at the same time.
- The sum total of the widths of all shadings needing alignment is less than 102".
- Side-by-side lineup is specified when the order is placed.

Vane Opening

Vane opening is the amount of unobstructed visibility between fully open vanes when looking through the shading at eye level. Vane opening for shadings is up to 1 3/8"

Vane Opening

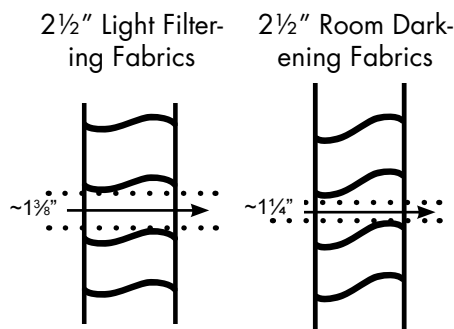

To Lower Cordless Paradise Shading

Pull down on the hinged pull until the shade is at the desired height.

To Raise Cordless Paradise Shading

Gently pull down on the hinged pull. To raise the shade completely, simply release the pull and the shade will roll up fully into the head rail. To raise the shade partially, when the shade is at the desired height, gently pull on the tassel to stop the shade from raising.



Cordless Handle on Window Sill

Paradise™ Sheer Shadings
CORDLESS HARDWARE SYSTEM

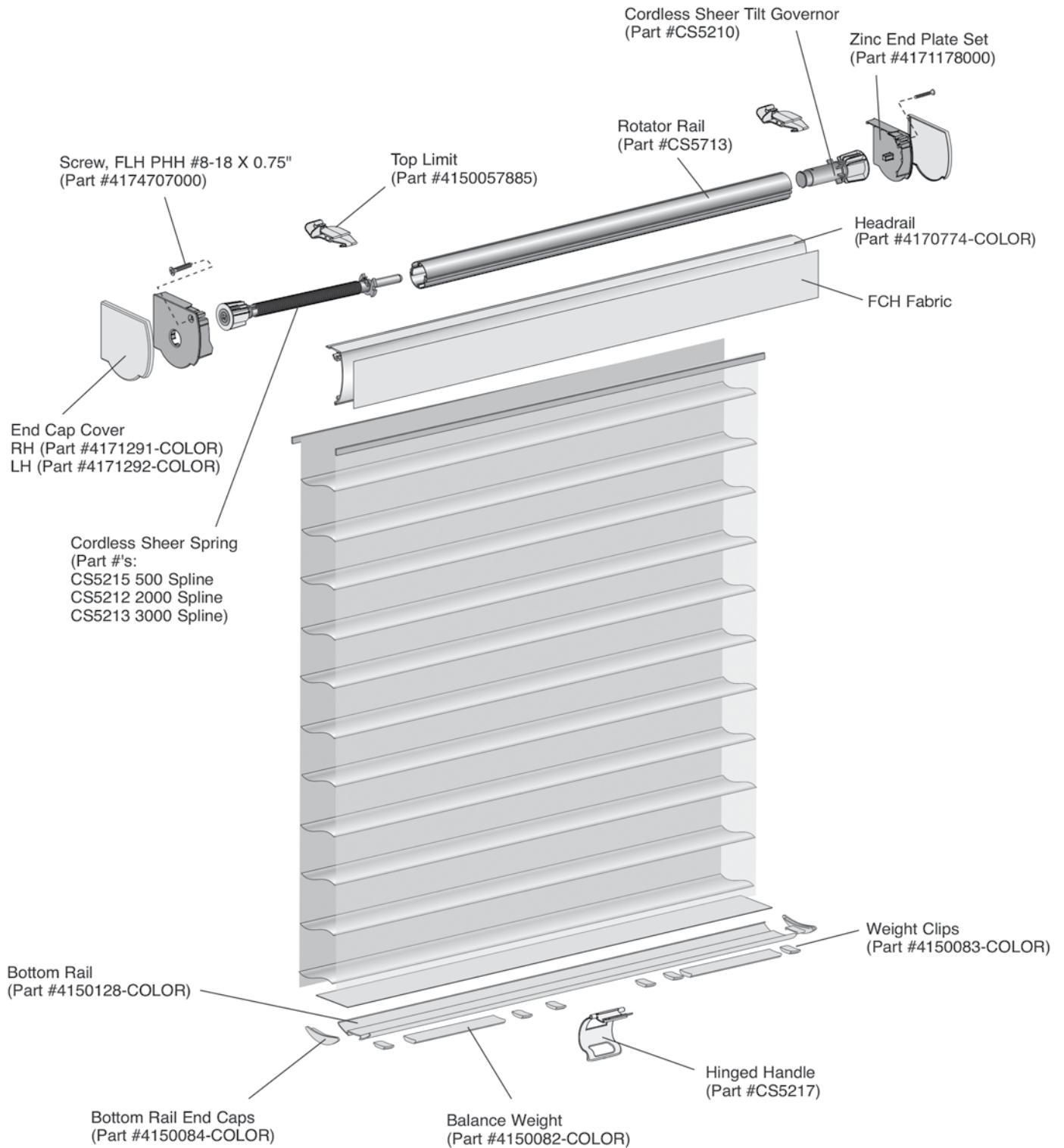

PARADISE SHEER SHADING

Paradise™ Sheer Shadings
RETRACTABLE CORD HARDWARE SYSTEM | DESIGNER CASSETTE HEAD RAIL

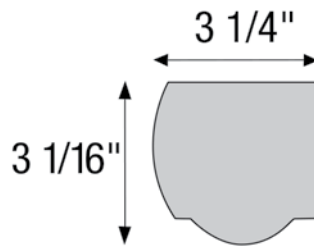

Retractable Cord Rail Dimensions

- Depth of cassette: 3 1/4"
- Height of cassette: 3 1/16"

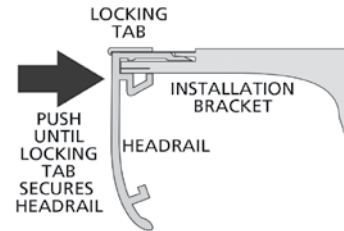

Hardware Features

Hardware colors for all Paradise fabrics	Choose from coordinating Fabric Insert or painted Smooth Face rail. Painted aluminum cassette head rail will be pre-coordinated to the fabric selection.
Retractable Cord	Cord coordinates with your hardware color.
Upgrades- No Charge	
Head Rail Insert	Fabric head rail fabric inserts are optional. The color of the fabric insert coordinates with fabric used on the shading and is not necessarily an exact match to the vane material. Color Coordinated endcaps.

Mounting Dimensions	Retractable Cord Hardware System
Minimum Depth Inside Mount	1"
Minimum Depth Flush Inside Mount	3 3/8"
Minimum Rear Fabric Clearance Inside Mount	1/8"
Minimum Surface Height Outside Mount	1"
Outside Mount Recommended Overlap Per Side	3"
Minimum Rear Fabric Clearance Outside Mount	1/8"

Finished Dimensions

Inside Mount	Outside Mount
<ul style="list-style-type: none"> • Fabric will measure ordered width less: 1" • Head rail* will measure ordered width less: 1/8"* 	<ul style="list-style-type: none"> • Fabric will measure ordered width minus: 3/4" • Head rail will measure ordered width • Fabric height will measure ordered length less: 1/8"

* Head rail measurements include endcaps.

Please Note: Due to variations in fabric weave and environmental conditions, the finished dimensions for both width and length may vary, plus or minus 1/8" from your order measurements.

Retractable Cord Shadings

- **To Lower the Shading:** To lower shading and open vanes, pull cord toward the center and down in long even strokes. Note: Allow cord to fully retract between each stroke. White, black or bronze cord and tassel coordinates your hardware color choice.
- **To Close and Raise the Shading:** To close vanes and raise shading, pull cord straight down or down and slightly out using long even strokes.

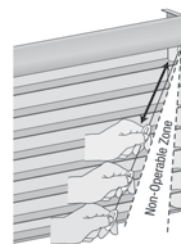

To Lower the Shading

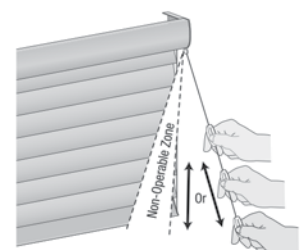

To Raise the Shading

Paradise™ Sheer Shadings

RETRACTABLE CORD HARDWARE SYSTEM

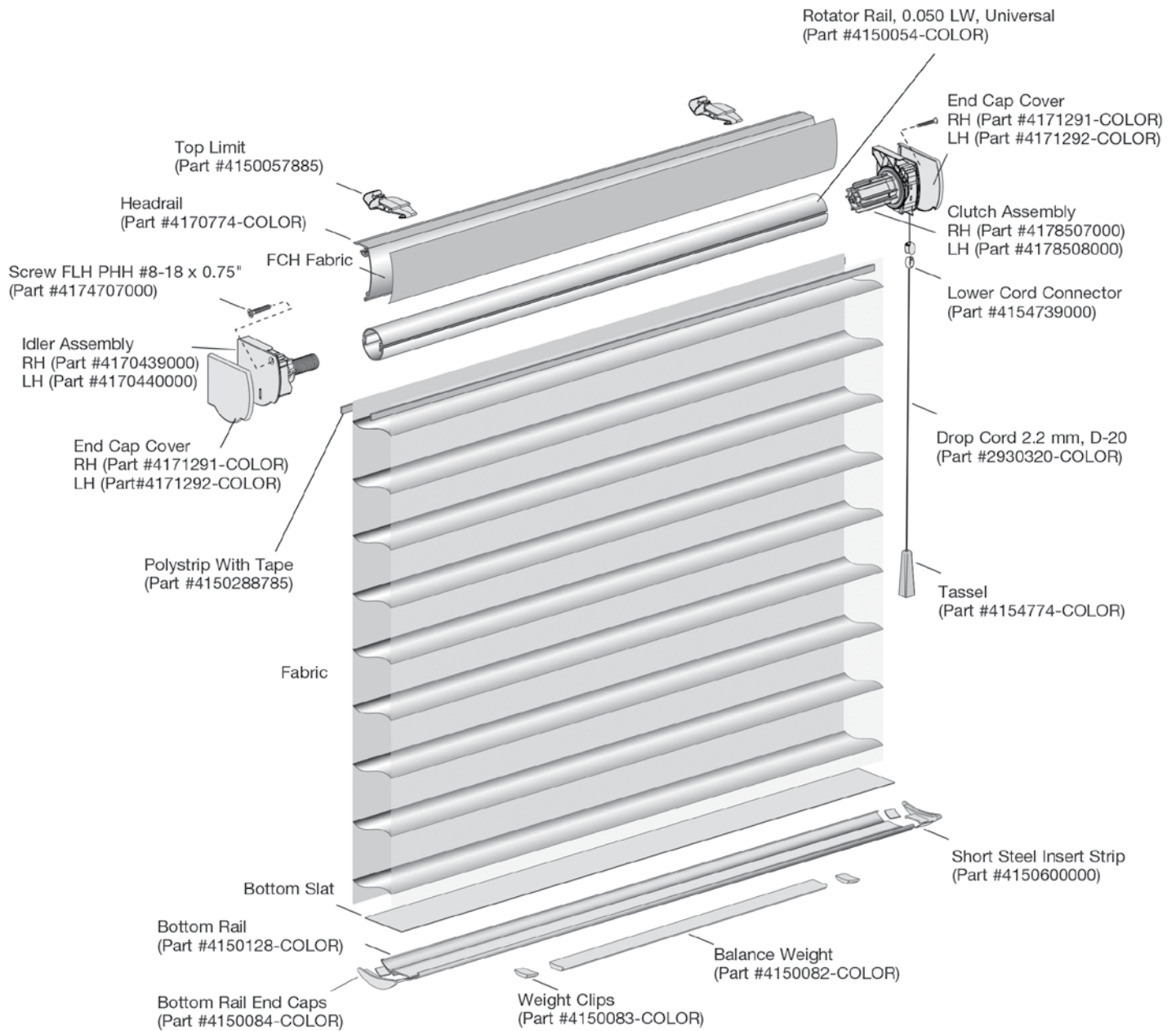

PARADISE SHEER SHADING

Paradise™ Sheer Shadings

7.4V RECHARGEABLE POWERTOCH HARDWARE SYSTEM | DESIGNER CASSETTE HEAD RAIL

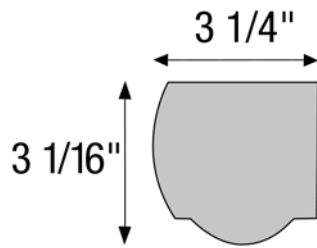
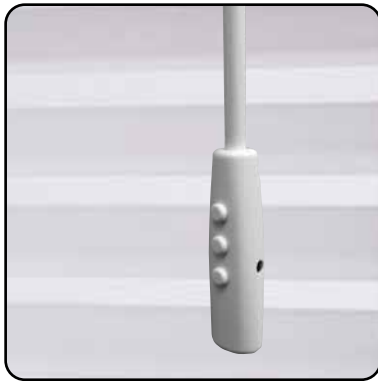

Rechargeable PowerTouch Rail Dimensions

- Depth of cassette: 3 1/4"
- Height of cassette: 3 1/16"

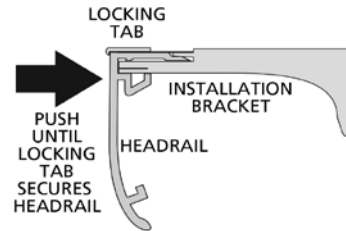

Hardware Features

Standard Designer Cassette	Choose from coordinating Fabric Insert or painted Smooth Face rail. Painted aluminum cassette head rail will be pre-coordinated to the fabric selection.
Bottom Rail Color	Color coordinated rail.
Upgrades- No Charge	
Head Rail Insert	Fabric head rail fabric inserts are optional. The color of the fabric insert coordinates with fabric used on the shading and is not necessarily an exact match to the vane material. Color Coordinated endcaps.

Mounting Dimensions

PowerTouch Hardware System

Minimum Depth Inside Mount	1"
Minimum Depth Flush Inside Mount	3 3/8"
Minimum Rear Fabric Clearance Inside Mount	1/8"
Minimum Surface Height Outside Mount	1"
Outside Mount Recommended Overlap Per Side	3"
Minimum Rear Fabric Clearance Outside Mount	1/8"

Finished Dimensions

Inside Mount

- Fabric will measure ordered width less: 1"
- Head rail* will measure ordered width less: 1/8"*

Outside Mount

- Fabric will measure ordered width minus: 3/4"
- Head rail will measure ordered width
- Fabric height will measure ordered length less: 1/8"

* Head rail measurements include endcaps.

Please Note: Due to variations in fabric weave and environmental conditions, the finished dimensions for both width and length may vary, plus or minus 1/8" from your order measurements.

Paradise™ Sheer Shadings

7.4V RECHARGEABLE POWERTOUCH HARDWARE SYSTEM | DESIGNER CASSETTE HEAD RAIL

PowerTouch™ Rechargeable Shades

Paradise Shades can be fabricated with the PowerTouch Rechargeable Push Button Control option. The PowerTouch Rechargeable option is an easy, cord free motorized operation for the budget savvy homeowner. PowerTouch Rechargeable uses Simplicity motors and components.

PowerTouch Rechargeable Shades Operation

Press the up or down button on the pendant to raise or lower the shading to your desired position.

No programming is required with PowerTouch™, all programming is set at the factory. Upper and lower limits easily can be adjusted in the field if desired. Favorites position can be programmed on-site. Please refer to the installation instructions at comfortex.com/comfortex-dealers.

PowerTouch Rechargeable Surcharges

See page 97.

PowerTouch Appearance

- The PowerTouch Rechargeable wand and pendant is attached to the head rail and requires no additional mounting.
- The wand and pendant hangs down the front of the shades from the head rail. The wand does not touch the fabric.
- Pendant is 2½" long.



PowerTouch Rechargeable Color Options

- Shadings with Black or Oil Rubbed Bronze hardware will be built with black wand and pendants standard. All other colors will use white wand and pendants.

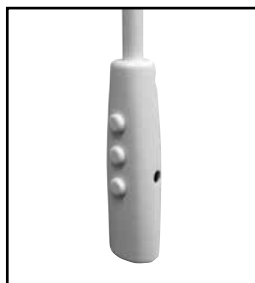

White



Black Shown with Plug-In Charger

PowerTouch Wand and Pendant Location

The standard location for the wand and pendant is on the right. Please specify location when ordering.

PowerTouch Rechargeable Wand Length

Size and color must be specified when ordered. Below is a recommended size chart.

Shading Length	Standard Wand Length
Up to 30"	1' (12")
>30" to 52"	2' (24")
>52" to 78"	3' (36")
>78" to 100"	4' (48")
>100" to 120"	5' (60")

- Wand length is in 1 foot increments. 1 foot - 5 foot

Mounting Requirements for PowerTouch Rechargeable Shades

- No special installation hardware or wiring requirements are needed.
- The wand and pendant do not need to be mounted to operate the shading.

PowerTouch Rechargeable Battery Life

The battery life will vary based on the type of window covering selected, the size and weight of the window covering and the number of times you operate the blind on a daily basis.

Battery Charger

8.4 Volt charger requires a standard power outlet to recharge the battery. Must specify charger when ordering a Simplicity PowerTouch Rechargeable Shading. The charger plugs into the charger port. The charger is black and comes with a 156" wire. The dimensions are 1" wide x 2½" length x 1¾" deep.



PowerTouch Rechargeable Shades Warranty

Please see page 114 for complete warranty information.

NEW Simplicity Bluetooth Motorization

Learn about Simplicity Bluetooth motorization and Comfortex FREE Color Lux Mobile App on page 18.

Paradise™ Sheer Shadings

7.4V RECHARGEABLE POWERTOUCHE HARDWARE SYSTEM | DESIGNER CASSETTE HEAD RAIL

PARADISE SHEER SHADING

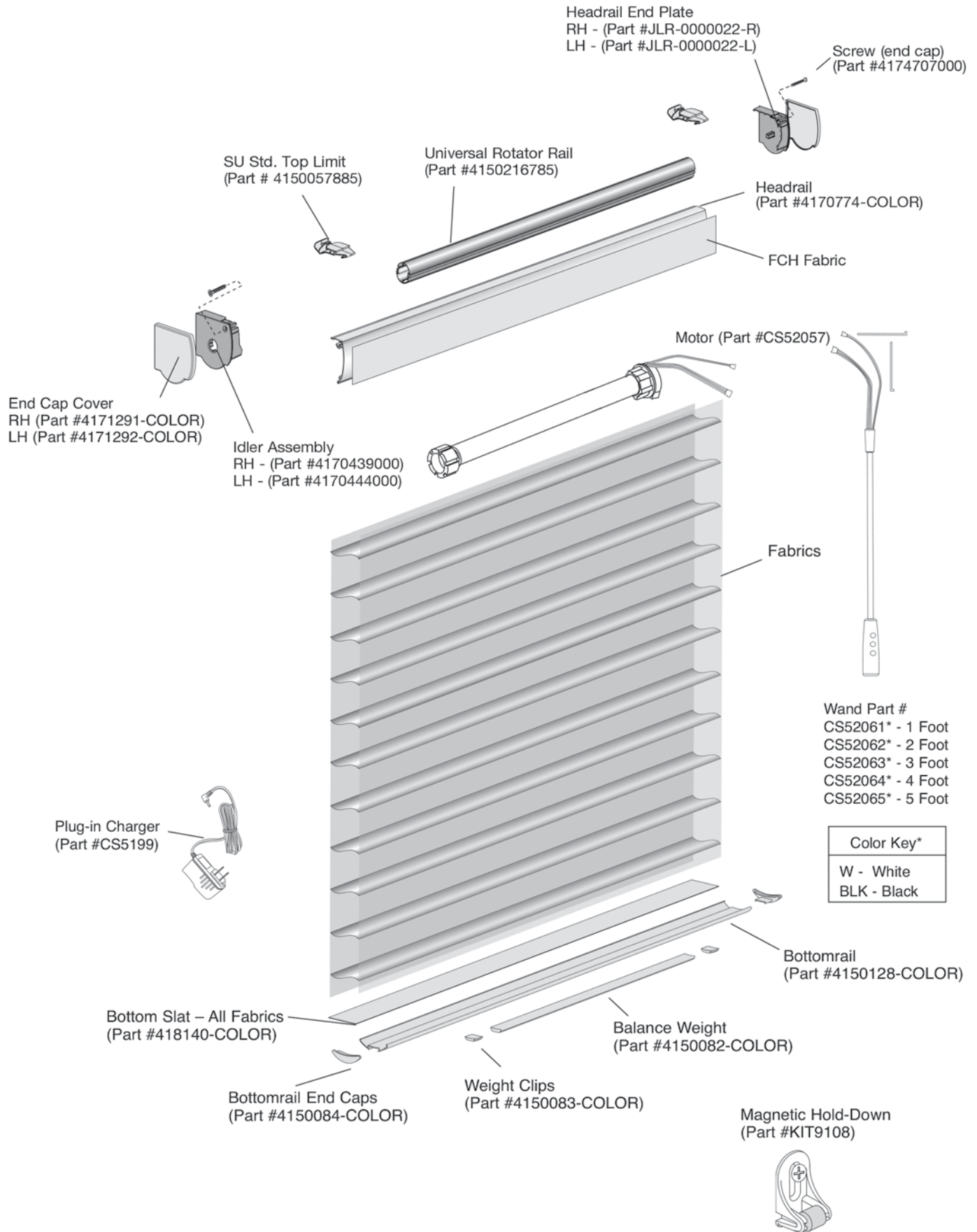

Paradise™ Sheer Shadings

7.4V RECHARGEABLE SIMPLICITY HARDWARE SYSTEM

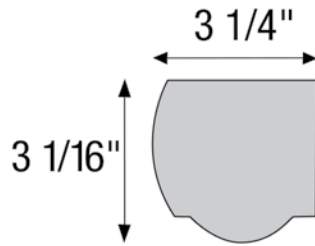

Rechargeable Simplicity Rail Dimensions

- Depth of cassette: 3 1/4"
- Height of cassette: 3 1/16"

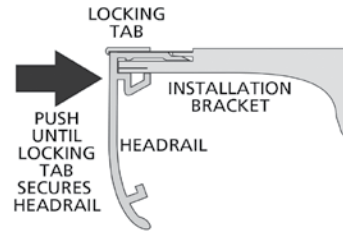

Hardware Features	
Hardware colors for all Paradise fabrics	Choose from coordinating Fabric Insert or painted Smooth Face rail. Painted aluminum cassette head rail will be pre-coordinated to the fabric selection.
Cord	A nylon cord is standard.
Upgrades- No Charge	
Head Rail Insert	Fabric head rail fabric inserts are optional. The color of the fabric insert coordinates with fabric used on the shading and is not necessarily an exact match to the vane material. Color Coordinated endcaps.
Mounting Dimensions	
Simplicity Integrated Rechargeable Hardware System	
Minimum Depth Inside Mount	1"
Minimum Depth Flush Inside Mount	3 3/8"
Minimum Rear Fabric Clearance Inside Mount	1/8"
Minimum Surface Height Outside Mount	1"
Outside Mount Recommended Overlap Per Side	3"
Minimum Rear Fabric Clearance Outside Mount	1/8"
Finished Dimensions	
Inside Mount	
	<ul style="list-style-type: none"> • Fabric will measure ordered width less: 1" • Head rail* will measure ordered width less: 1/8"*
Outside Mount	
	<ul style="list-style-type: none"> • Fabric will measure ordered width minus: 3/4" • Head rail will measure ordered width • Fabric height will measure ordered length less: 1/8"
* Head rail measurements include endcaps.	
Please Note: Due to variations in fabric weave and environmental conditions, the finished dimensions for both width and length may vary, plus or minus 1/8" from your order measurements.	

Paradise™ Sheer Shadings

7.4V RECHARGEABLE SIMPLICITY HARDWARE SYSTEM

Simplicity Rechargeable Motors

The Rechargeable Simplicity Motor program features an integrated rechargeable lithium ion battery in the motor casing and is fully concealed by the roller tube.

PowerTouch Integrated Rechargeable Surcharges

See page 62 for shading standards and page 62 for surcharges and pricing example.

Simplicity Rechargeable Motors

No special installation hardware or wiring requirements are needed to install motorized Shangri-La Shadings with Designer Cassette Head Rail. No external battery wand is required.

Rechargeable Simplicity Motor Batteries

The battery for the integrated rechargeable simplicity motor system is integrated within the motor casing and is fully concealed by the roller tube.

Rechargeable battery comes fully charged from the factory.

Integrated Rechargeable Motor Battery Life

Rechargeable battery is included with the motor.

The average battery charge will last 6-12 months based on an average sized shade raised and lowered once per day. The life of the battery charge will vary based on the type of window covering selected, the size and weight of the window covering and the number of times the shade is operated on a daily basis.



Charging Port

The battery can be recharged up to 500 times. It takes approximately 5 hours to recharge the motor when fully depleted.

Integrated Rechargeable Motor Battery Charger

An 8.4 Volt charger requires a standard power outlet to recharge the battery. The charger must be specified when ordering an Integrated Rechargeable Simplicity Motorized shade. The charger plugs into the charging port of the motor. Required with Integrated Shading order. Sold separately.



The charger is black and comes with a 156" wire. The dimensions are 1" wide x 2½" length x 1¾" deep.

Simplicity Motor Hand Held Remotes

IMPORTANT: Simplicity Rechargeable Motorized Shadings are programmed at the factory with the "up and down" limits. The shades are **UNLINKED** from the remote so they are not able to operate during shipping. Each shade should be installed **before** linking it to the remote.

5 Channel Remote

The **5 Channel (5C) remote** can operate up to five shadings simultaneously, individually or in groups.

Simplicity (5C) remotes and holders are black in color. The remote comes with a holder which can be mounted to a wall for easy storage. The range of the remote is approximately 80 feet.



14 Channel Remote

This remote has 14-channels. Each channel has a setting to operate the bottom rail. The **14 Channel remote** can operate up to fourteen shades individually or 14 groups.

14 Channel remotes and holders are white in color. The remote comes with a holder which can be mounted to a wall for easy storage. The range of the remote is approximately 80 feet.



Please Note:

- Not all motors run at the same rate of speed.
- Simplicity motors have a "Favorites" or "MY" position setting. If the homeowner wants to set several shadings at the same intermediate position, follow instructions provided with installation manual.
- **WHEN ORDERING THE NEW INTEGRATED RECHARGEABLE, PLEASE ORDER THE NECESSARY BATTERY Charger** information.

Solar Panel Recharge Option

Plugs in to any Simplicity Rechargeable Remote control shade (does not work with PowerTouch). See page 56.



Dimensions of panel
18½" x 1½"

Paradise™ Sheer Shadings

7.4V RECHARGEABLE SIMPLICITY HARDWARE SYSTEM

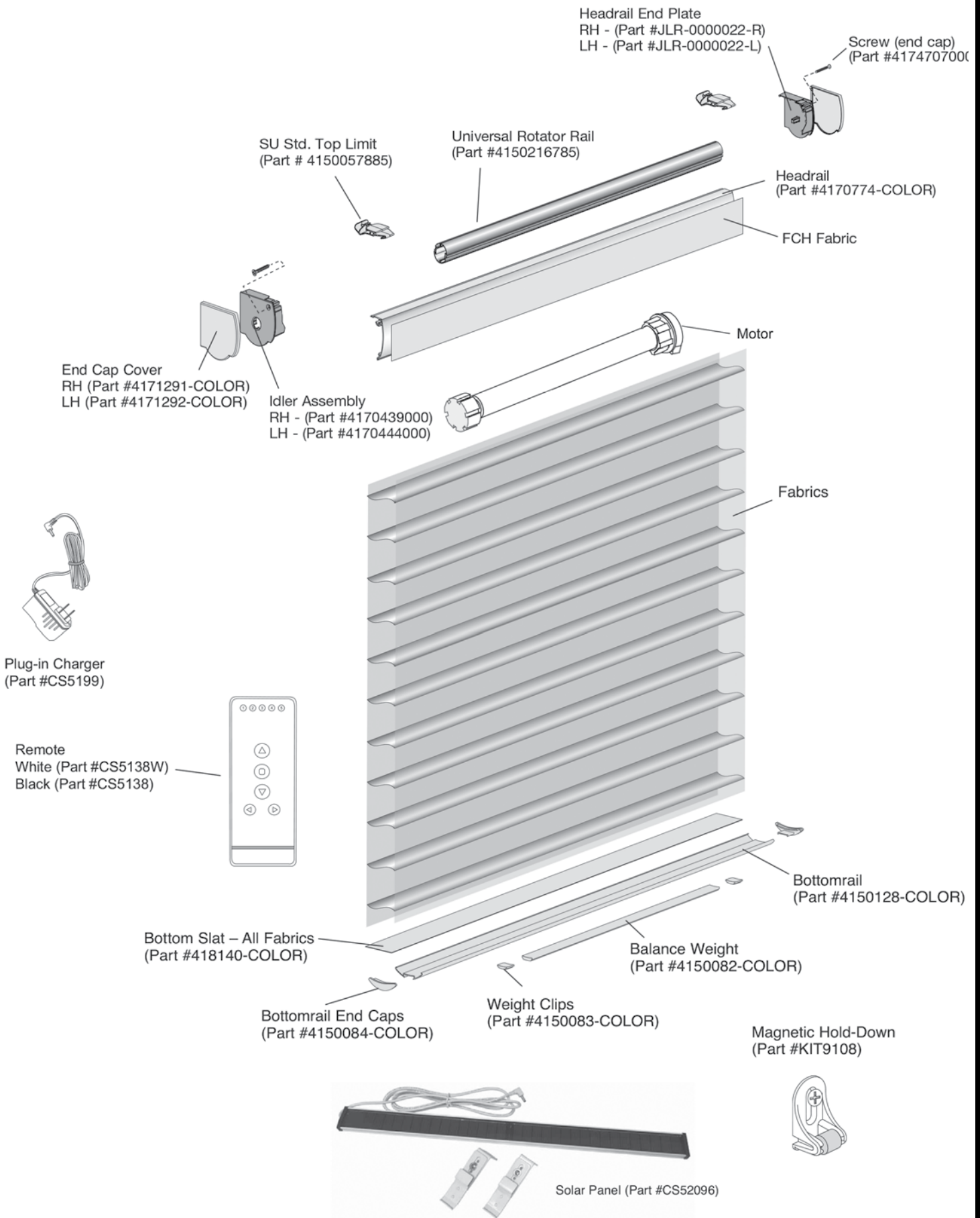

PARADISE SHEER SHADING

Paradise™ Sheer Shadings

OPTIONS | ADDITIONAL NOTES

Optional Back Cover (Inside Mount)

Used with inside mounts to conceal the open rear side of the headrail for a more pleasing exterior look. Use of the back cover adds 1/4" to minimum inside mounting depths.

Minimum Inside Mounting Depth

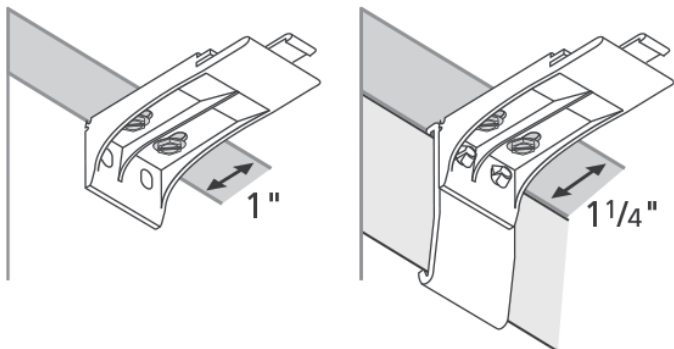

Without Back Cover

Back Cover

The back cover is secured in place by a back cover bracket attached to the installation bracket.

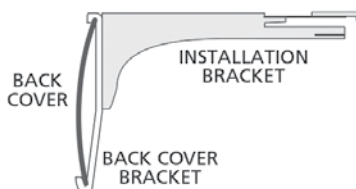

Back Cover Bracket

When a back cover is used, attach back cover brackets to the installation brackets before mounting them. Remove the tab from the top of the back cover brackets and both tabs at the rear of the installation brackets. After mounting the installation brackets, install the back cover.

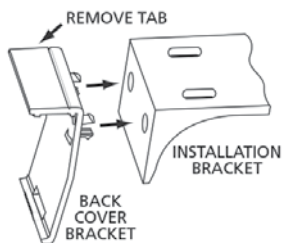

Optional Dust Cover (Outside Mount)

Shields the fabric and internal headrail components from dirt, dust, and other contaminants.

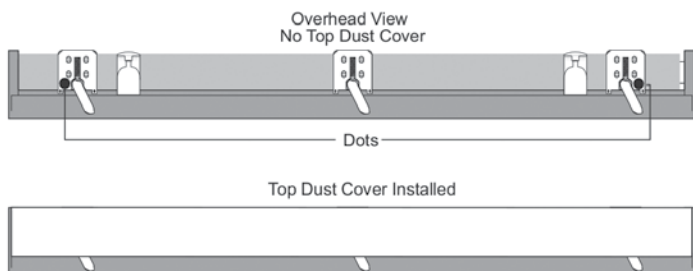

Shading Installation

Used with inside mounts to conceal the open rear side of To mount the shading, insert the top of the headrail into the brackets between the locking tab and the bracket flange. Push the headrail into the brackets until the locking tab clicks in place.

To remove the shading, lift the locking tab to release the headrail, rotate the headrail forward, and pull it straight out.

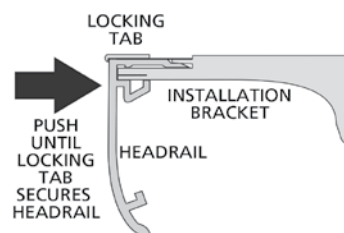

VERTICAL SHEER SHADINGS



- Vertical Sheer Shadings combine the elegance and softness of sheer shadings with the light control of vertical blinds giving you unlimited ways to control light.
- Vertical Sheer Shadings are available up to 192" wide and to heights up to 120". Vertical Sheer Shadings are perfect for wide expanses of windows and doors.
- Vertical Sheer Shadings are available in six neutral colors, all made of 100% polyester that is durable yet soft to the touch.
- To ensure child safety, a combination wand and cord and moving wand operating systems have no dangling cords.
- For a coordinated look, Vertical Sheer Shadings can be paired with Shangri-La® Sheer Horizontal Window Shadings.
- Our Vertical Sheer Shadings are beautiful and smart with the added benefit of 99% UV protection to protect artwork and home furnishings from the damaging effects of the sun.
- Vertical Sheer Shadings are custom crafted and assembled in the U.S. and backed by the Comfortex Lifetime Guarantee.

Vertical Sheer Shadings

SIZE STANDARDS

		Wand/Cord	Moving Wand*
Vertical Sheer Shadings	Minimum Width	12"	12"
	Minimum Length	24"	24"
MAXIMUMS			
Vertical Sheer Shadings	Maximum Width	192"	144"
	Maximum Length	120"	100"

Please Note: Two side stack shadings (one left and one right) may be abutted to achieve larger maximum widths. This is not recommended with moving wands.

*Moving wand is only available with outside mount side stack shadings.



Vertical Shadings Panel Design

Comfortex Vertical Sheer Shadings features contoured sheer fabric columns with soft 3½" fabric vanes attached.

The top of the Vertical Sheer Shadings features a 5¼" fabric header that conceals the hardware.

Choose from light filtering or room darkening vanes.

Finished Dimensions

Inside/Ceiling Mount

Fabric Width	<ul style="list-style-type: none"> Fabric will measure ordered width less: ¼" Side Stack Head rail will measure ordered width less: 1½" Split Stack Head rail will measure ordered width less: 1¼"
Fabric Length	<ul style="list-style-type: none"> Fabric will measure ordered length (overall) less: 1" Top Clearance will measure ordered length less: ½" Bottom Clearance will measure ordered length less: ½"
Fabric Header Height	<ul style="list-style-type: none"> 5¼"

Outside Mount

Fabric Width	<ul style="list-style-type: none"> Fabric will measure ordered width Side Stack Head rail will measure ordered width less: 1¼" Split Stack Head rail will measure ordered width less: 1"
Fabric Length (for top clearance)	<ul style="list-style-type: none"> Fabric will measure ordered length minus: ½"
Fabric Header Height	<ul style="list-style-type: none"> 5¼"

Please Note: Width and length measurements may vary +/- ⅛"

Vertical Sheer Shadings

PRICING

3½" Vertical Sheer Shadings

PRICE GROUP 21 Light Filtering

		Width In Inches																	
		24	36	48	54	60	66	72	78	84	90	96	108	120	132	144	156	174	192
Length In Inches	48	1124	1397	1641	1760	1887	2055	2178	2298	2433	2605	2768	2982	3568	3943	4214	4481	4748	5139
	60	1248	1563	1853	1998	2158	2357	2496	2639	2796	2998	3182	3439	4048	4452	4746	5037	5318	5750
	72	1360	1764	2133	2307	2496	2715	2894	3063	3254	3490	3697	4259	4948	5439	5805	6186	6541	7105
	84	1456	1911	2375	2570	2775	3026	3214	3419	3616	3877	4115	4452	5164	5665	6053	6449	6828	7403
	96	1571	2071	2512	2710	2937	3197	3405	3618	3835	4122	4365	4829	5578	6126	6542	6974	7398	8027
	108	1876	2471	3043	3324	3650	4004	4273	4557	4831	5168	5469	5932	6654	7203	7635	8068	8466	9114
	120	2109	2772	3448	3773	4193	4617	4929	5265	5596	5977	6305	6856	7527	8074	8500	8933	9293	9922

Solid lines indicates the maximum width and length of Vertical Sheer Shadings available with a Moving Wand.

3½" Vertical Sheer Shadings

PRICE GROUP 22 Room Darkening

		Width In Inches																	
		24	36	48	54	60	66	72	78	84	90	96	108	120	132	144	156	174	192
Length In Inches	48	1322	1641	1927	2069	2219	2415	2562	2701	2860	3063	3252	3506	4193	4633	4955	5269	5579	6045
	60	1469	1838	2180	2349	2534	2770	2935	3102	3286	3516	3741	4040	4757	5231	5574	5921	6248	6763
	72	1600	2076	2506	2710	2935	3192	3403	3602	3825	4097	4344	4999	5811	6391	6818	7269	7687	8353
	84	1712	2245	2794	3019	3266	3555	3781	4019	4255	4555	4829	5228	6067	6659	7114	7580	8023	8699
	96	1844	2433	2949	3188	3453	3759	4004	4259	4512	4835	5124	5673	6552	7196	7686	8192	8693	9436
	108	2205	2901	3579	3905	4293	4706	5024	5359	5680	6074	6424	6967	7817	8462	8971	9482	9952	10707
	120	2480	3263	4050	4436	4929	5428	5796	6191	6582	7020	7406	8057	8843	9482	9984	10493	10922	11661

Solid lines indicates the maximum width and length of Vertical Sheer Shadings available with a Moving Wand.

LIFT SYSTEM AND DESIGN UPGRADES		ADD
	Split Stack Moving Wand (Available on Outside Mount Shadings only)	\$467 FREE

Vertical Sheer Shadings

GENERAL INFORMATION

Product Configurations

Choose from three stacking designs: left stack, right stack or split stack.

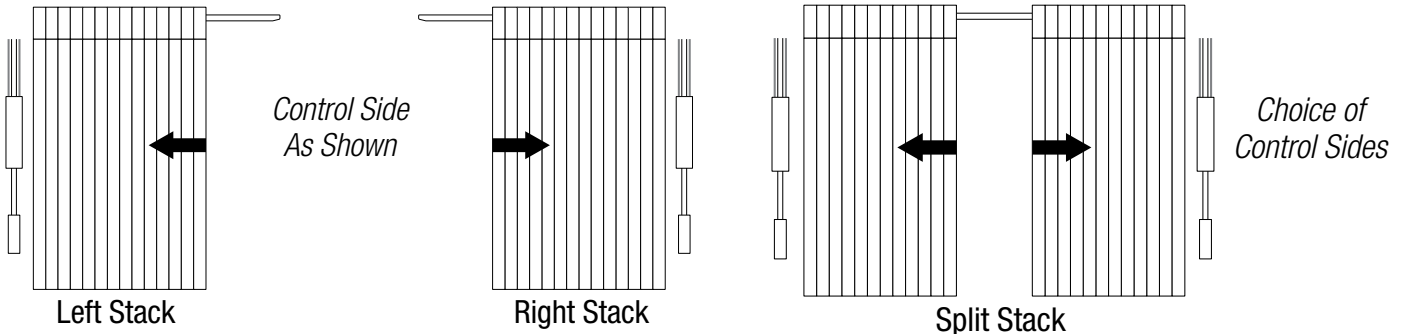

Inside Mount Finished Dimensions

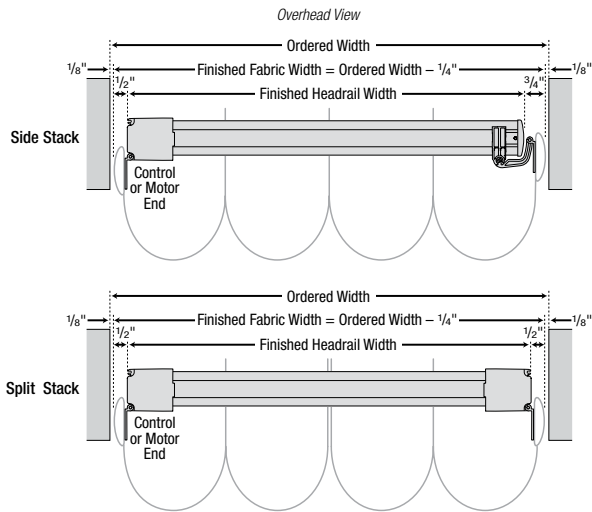

Outside Mount Finished Dimensions

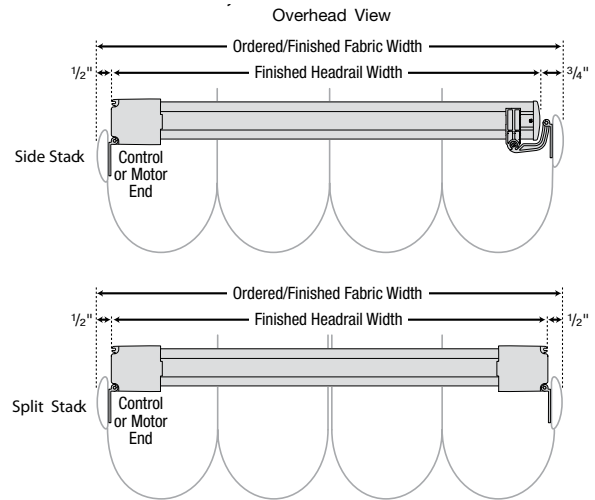

Vertical Sheer Shadings

GENERAL INFORMATION

Vertical Sheer Shadings Fabrics and Vanes

Vertical Sheer Shadings are a beautiful option for covering a variety of windows. However, they are a textile product which will never be perfect. By understanding some of the qualities of the fabric used in Vertical Sheer Shadings, you will be able to set clear expectations during the sales process.

Fabric and Vanes

- Vertical Sheer Shadings are 100% polyester for durability and easy care. The 3 1/2" stationary vanes are permanently bonded to the rear of the face fabric, providing a uniform appearance to the home's exterior.
- Color is carried by the sheer fabric; vanes are white.
- Vanes available in two opacities: light filtering and room darkening.
- The Vertical Sheer Shadings fabrics are subject to the variations associated with all textiles, such as slight wrinkles or puckers.

Tiltback

Additional weight of the face fabric in front causes the fabric to hang at a slight angle, called "tiltback." This is an inherent characteristic of the product and may be more noticeable on shorter panels.

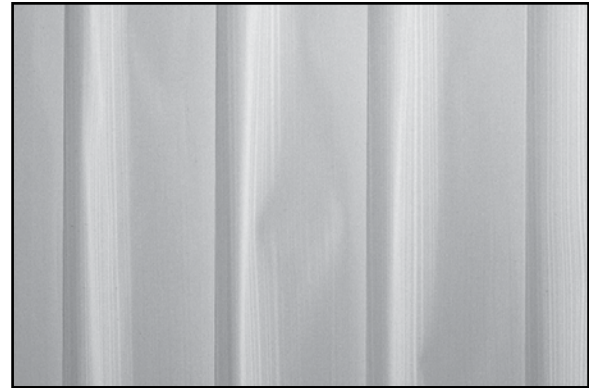
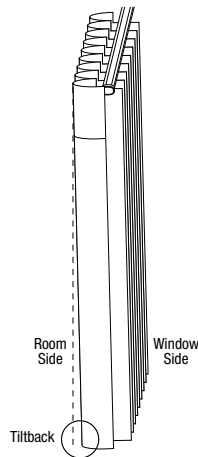

Puckering



Tilt Back



Vertical Sheer Shadings

GENERAL INFORMATION

Vertical Sheer Shadings Hardware

Vertical Sheer Shadings use a proven scissor track system. Track system is white and hidden behind the fabric header.

Scissors expand when the sheer is drawn closed and compress when the sheer is drawn open.

Vane realignment is easy — rotate the vanes first to one side and then the other.



Controls and Control Placement

Vertical Sheer Shadings are operated with wand/cord combination or a moving wand option.

Wand/Cord Control

- With the wand/cord, pull the cord to traverse the fabric and twist the wand to rotate the vanes. Be sure to use both hands to avoid twisting the cord.
- Wand/cord placement: the shading stacks on same side as wand/cord; for split stack or offset stack, choose left or right control.
- See the next column for standard wand/cord lengths.



Moving Wand

- The moving wand is a cordless wand control system that traverses the fabric and rotates the vanes.
- Moving wand is available with **outside mount shadings only**.
- The placement of moving wand is opposite side of stack.
- See the next column for standard wand lengths.



Wand/Cord Lengths

- Wand/cord length is measured from top of fabric to bottom of wand.
- **Placement:** Wand/cord: the shading stacks on same side as wand/cord; for split stack or offset stack, choose left or right control.

Ordered Shading Length	Standard Wand/Cord Length
24" to 40"	24"
40 ¹ / ₈ " to 60"	36"
60 ¹ / ₈ " to 96"	48"
96 ¹ / ₈ " to 108"	60"
108 ¹ / ₈ " to 120"	72"

- Custom lengths for the wand/cord may be specified when ordering. Choose from 24", 36", 48", 60" and 72" lengths at no additional charge.
- Non-standard wand/cord lengths are not available.

Moving Wand Length

- Wand length is measured from top of fabric to bottom of wand.
- **Placement:** Moving wand: the shading stacks on opposite side of wand; available on outside (OB) mount side stack only.

Ordered Shading Length	Wand Length
24" to 48"	23"
48 ¹ / ₈ " to 84"	30"
84 ¹ / ₈ " to 100"	40"

Vertical Sheer Shadings

GENERAL INFORMATION

Vertical Sheer Shadings Design and Operation

Outside Mount Installation

Specifying Vertical Sheer Shadings as outside mounts is ideal because the vanes and fabric are allowed to operate freely.

- Outside mounts provide complete fabric coverage and enhance light control and privacy features.
- Outside mounts allow the shading to be stacked back off of the window opening for an unobstructed view.

WHY INSIDE MOUNTS ARE NOT RECOMMENDED

- Vertical Sheer Shadings are not recommended as inside mounts due to light gaps that occur on the sides of the sheer when the vanes are closed.
- Inside mounting prevents the end treatments from rotating with the vanes. This results in light gaps on the sides of the sheer when the vanes are closed, as well as compressed end fabrics.

Vane Closure Gap

The closed vanes of Vertical Sheer Shadings are designed to overlap for privacy when viewed straight on.

- Light leakage may occur due to the vane closure gap, which may increase with the length of the shading.
- The vane closure gap is most visible when viewed from the side. It is a normal, inherent characteristic of the product and should not be considered a defect.
- Vane closure is tighter in one direction than the other when the vanes are rotated closed.

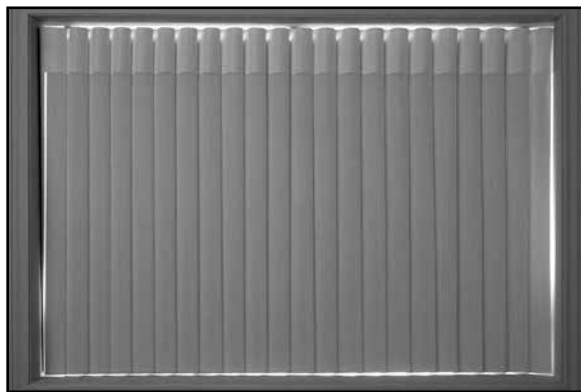
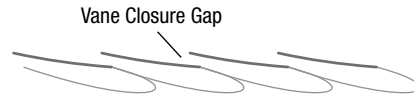

Light gaps around the window frame that occur with Inside Mount Shadings

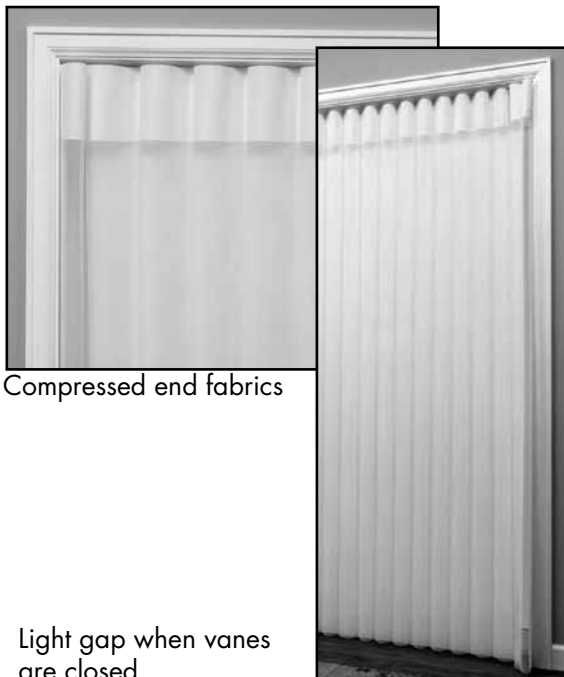

Compressed end fabrics

Light gap when vanes are closed

Vertical Sheer Shadings

GENERAL INFORMATION

Split Stack Center Gap

- The maximum distance between fabric panels of a split stack design is 1/4".

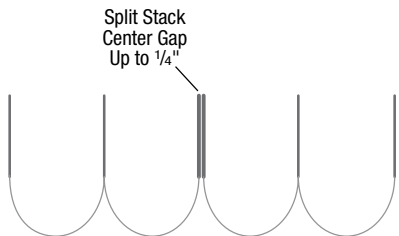

Side-By-Side (Abutted) Applications

- Outside-mounted side stack shadings may be abutted at the non-control ends to achieve wider widths up to 384".
- Abutted applications utilize two independent head rails and will appear and function differently than a split stack application utilizing a single head rail.
- No deductions or special order entries are necessary.
- At installation, position the ends of the rails 1 1/2" apart for optimal appearance and function.
- Please Note:** The moving wand is not recommended for abutted applications.

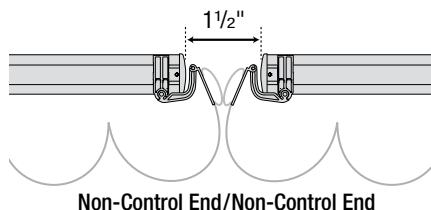

Abutted Gap

- For best closure on shadings with abutted installations, the vanes should be rotated in opposite directions to minimize the abutted gap, as shown below.

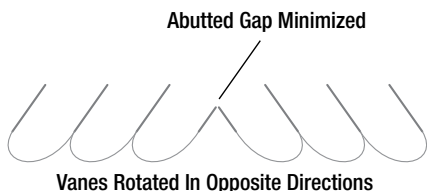
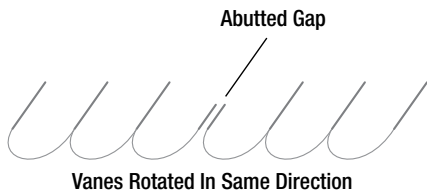

Return Gaps

Outside mount applications have return gaps, which is the distance between the end treatments and the wall.

Gap Dimensions

Return Gap — Side Stack

- Control (wand/cord) end 2"
- Non-control (traveling) end 1 1/2"

Return Gap — Split Stack

- Both ends 2"

Center Gap

- Split stack up to 1/4"

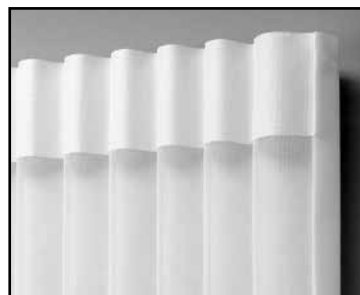
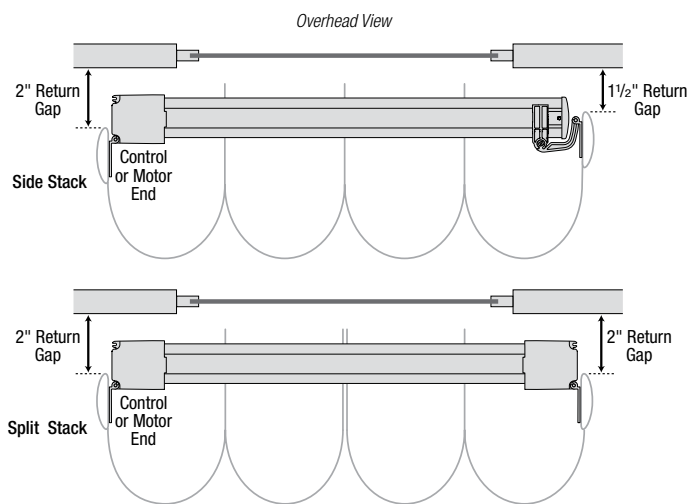

Return gap

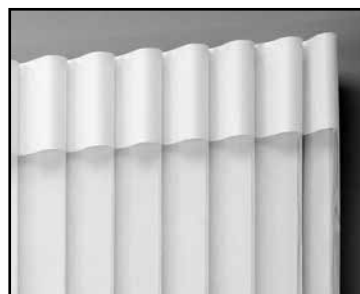

All vanes fully rotate

Vertical Sheer Shadings

GENERAL INFORMATION

Measuring, Mounting Requirements and Installation Information

- Outside mount applications are highly recommended. Inside mount installations **are not recommended** due to the light gaps that occur when the vanes are closed.
- Moving wands control option is only available with outside mount side stack shadings.
- **Top clearance is required for head rail installation.** The rail must be tilted upward to fit into the installation bracket faceplate.

Installation Brackets

- Installation bracket faceplates with spacer blocks are used for outside mounts.
- Inside/ceiling mount brackets are used for inside and ceiling mounts. These brackets are also used with extension brackets for outside mounts needing extra clearance.

Ordered Width	Installation Brackets Required
Up to 40"	2
40 1/8" to 70"	3
70 1/8" to 96"	4
96 1/8" -155"	6
155 1/8" -192"	8

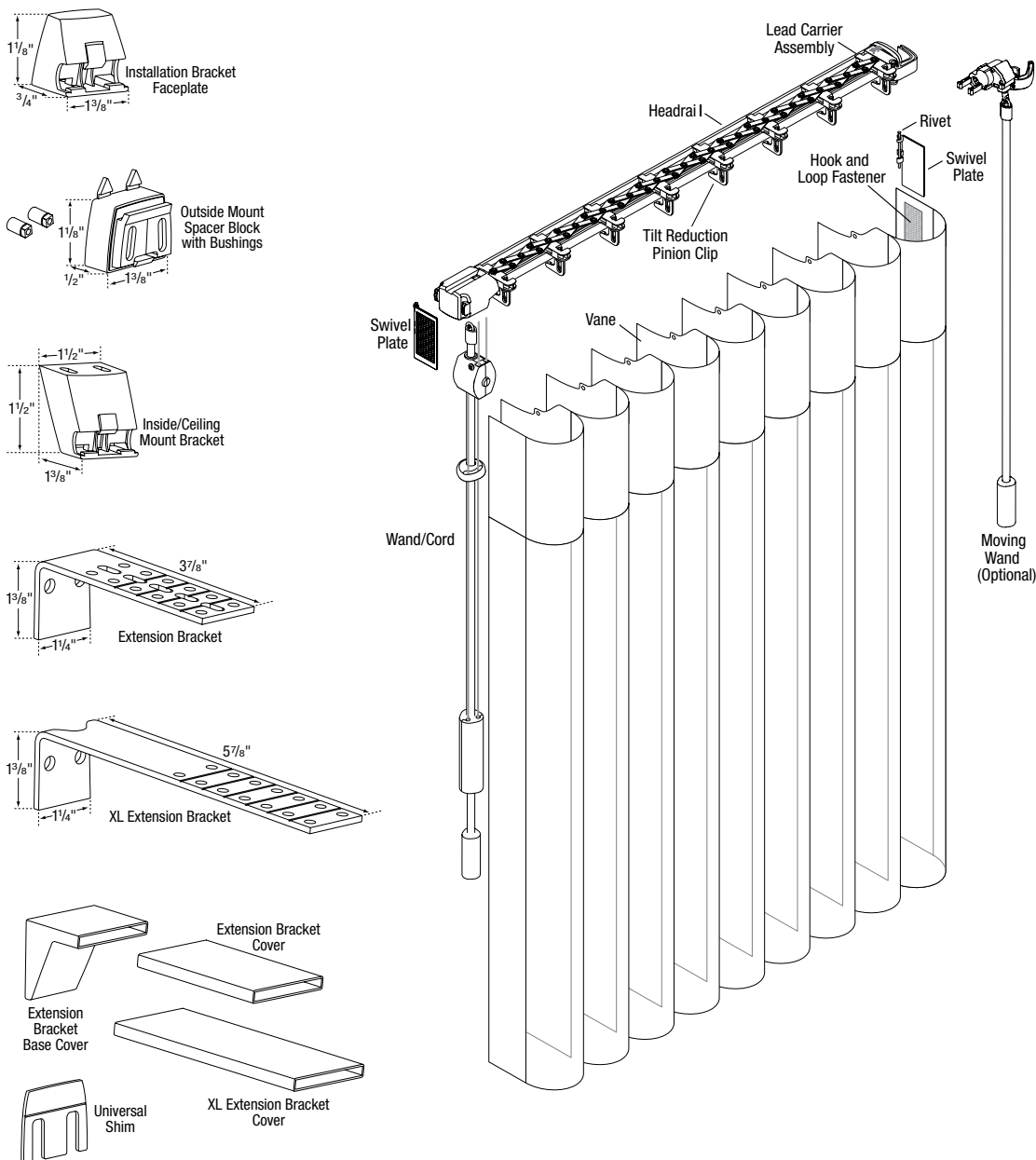

Vertical Sheer Shadings

GENERAL INFORMATION

Measuring, Mounting Requirements and Installation Information

Outside Mount

- Minimum mounting surface height with Standard Bracket: 1 1/8"
- Minimum mounting surface height with Extension Bracket: 1 3/8"
- Recommended top overlap: 5"
- Recommended minimum overlap per side (and bottom overlap when product does not hang to floor): 5"
- Recommended bottom clearance when product hangs to floor (deduct before ordering): 1/2"

Outside Mount Ordered Height

- Outside mount ordered height is the distance from the bottom of the fabric to 1/2" above the top of the fabric, where the top of the bracket tab will be located.
- When measuring, plan on the bottom of the fabric being located a minimum of 1/2" above the floor for operating clearance.
- Allow the recommended amount of top overlap and check that the bracket can be mounted on a 1 1/8" flat, not curved, vertical surface.

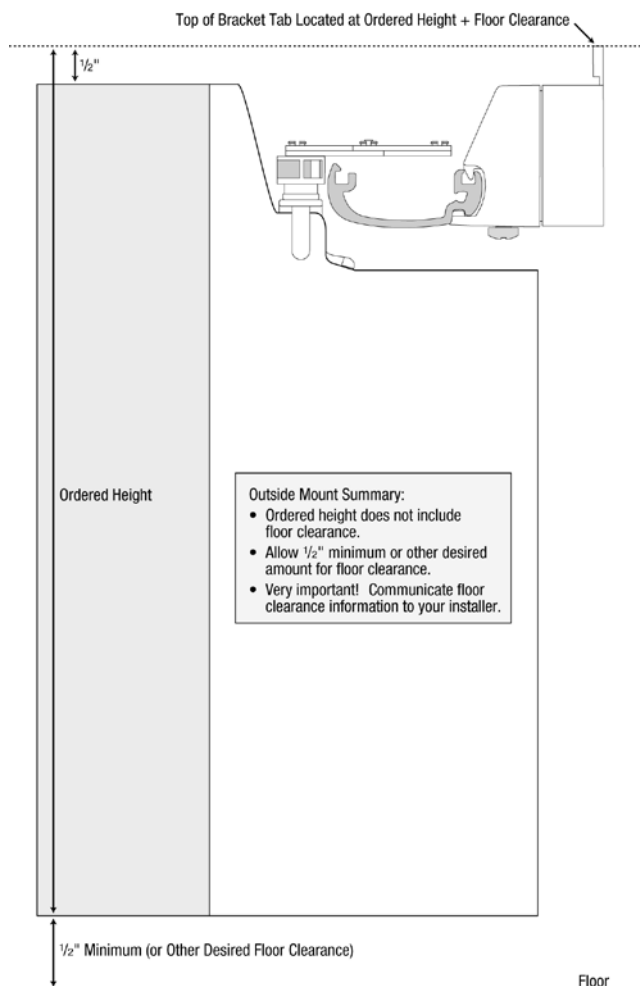

Inside/Ceiling Mount

Inside/ceiling mount brackets are used for inside and ceiling mounts. These brackets are also used with extension brackets for outside mounts needing extra clearance.

- Minimum mounting depth: 1"
- Minimum mounting depth, fully recessed: 6 1/4"

Spacer Blocks

- Each spacer block projects an outside mount installation bracket 1/2" away from the mounting surface.
- There must be sufficient rear clearance for proper operation.
- One spacer block is required for the 3 1/2" vane size.

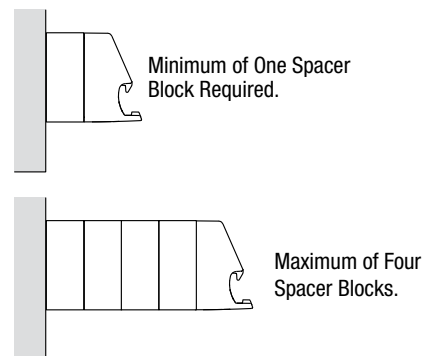

Extension Brackets

- Standard extension brackets can provide up to 3 1/2" of clearance.
- Extra Large extension brackets can provide up to 5 1/2" of clearance.

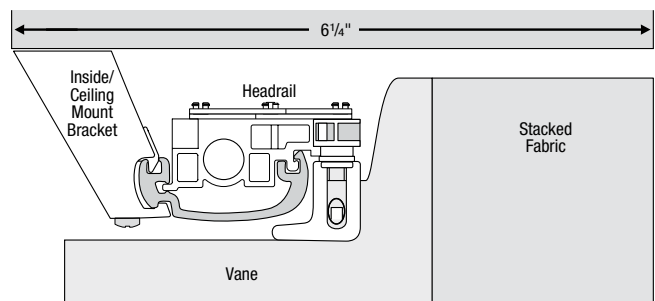

Vertical Sheer Shadings

GENERAL INFORMATION

Measuring for Corner Windows

- Measure the width of both openings to the common corner.
- Deduct the depth of the treatment from the width of each measurement so they will meet in the corner but not overlap. Deduct 3".
- If additional spacer blocks or extension brackets will be used for extra clearance on outside mounts, add the amount of extra clearance to the deduction.
- Order the width less the deduction for each window.

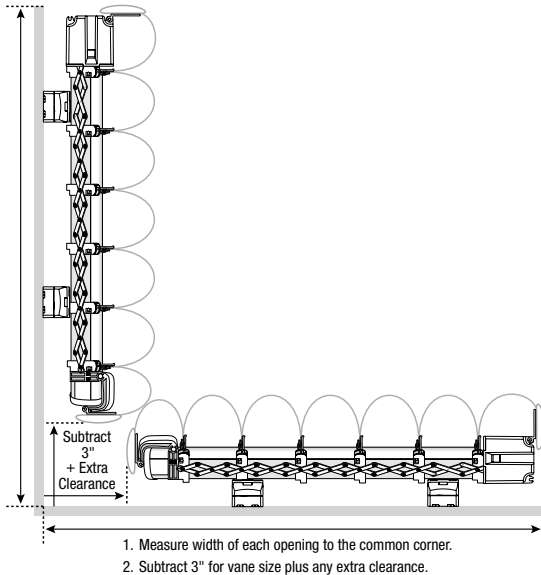

How to Avoid Common Ordering Errors

- If an outside mounted Vertical Sheer Shading hangs to the floor, allow for a minimum of ½" for floor clearance.
 - Allow for more clearance, if needed (with thick pile carpet, for example).
 - Be sure the installer understands your floor clearance allowance so that he or she mounts the brackets at the proper height.
- Be sure to measure for the recommended outside mount height and width overlaps. Include Stackback, if desired (see pages 94-95).
- With side stack Vertical Sheer Shadings, specify the correct stacking side.
 - If a sliding glass door opens on the right side (slides to the left), order a left stack.
 - If it opens on the left side (slides to the right), order a right stack.

Vertical Sheer Shadings

GENERAL INFORMATION

Stackback

- Outside mounted shadings may be ordered so that the window opening is completely uncovered when the fabric is drawn open, as shown in the illustrations at the bottom of the page.
- Refer to the Stackback charts on page 95.
- Stackback is measured at the top of the shading.

Using the Stackback Charts

- Determine the desired uncovered width when the shading is drawn fully open.
 - With side stack designs, be sure to include in your uncovered width measurement the desired fabric overlap on the side opposite the fabric stack.
- Locate that width on the Stackback chart.
- Move across the row to find the correct ordered width.
- The Stackback dimension is shown in the column between the uncovered width and ordered width.
- Determine the desired uncovered width when the shading is drawn fully open.

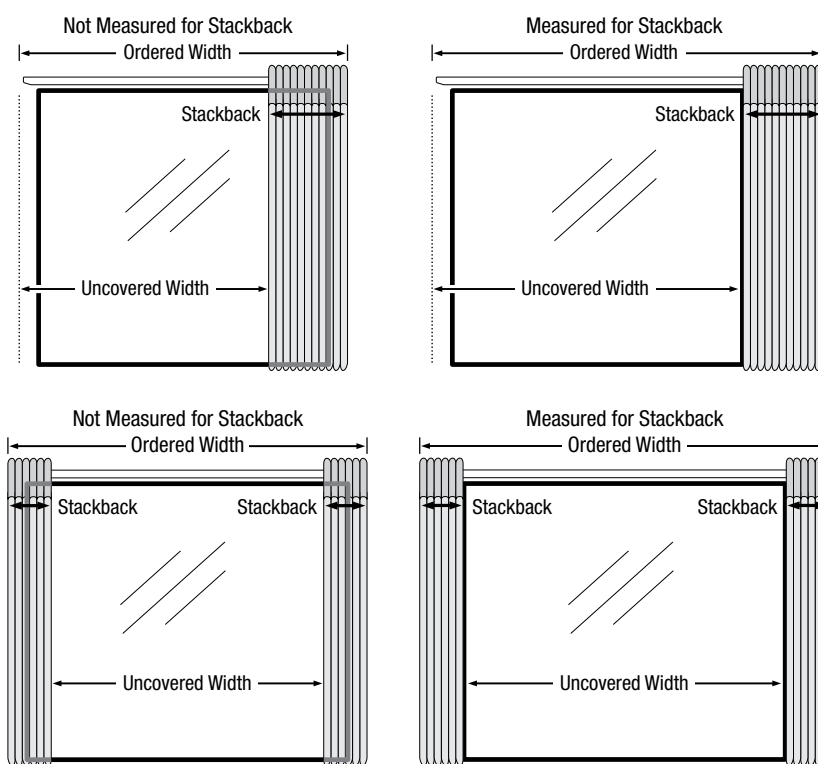

UV Protection

Ultraviolet light, entering the home as sunlight, damages furnishings. In time it fades wood floors, furniture, upholstery, draperies, carpeting and artwork. Prolonged exposure to sunlight causes natural, undyed fabrics to turn yellow, weakening their fibers and making them look old and worn prematurely.

The right window covering can be very effective in blocking ultraviolet rays. Such effectiveness is measured in terms of a “% UV blockage” rating. The higher the rating, the greater the UV protection.

Vertical Sheer Shading fabrics have the following UV Protection ratings:

Open Vanes	88%
Closed Vanes	99%

Vertical Sheer Shadings

GENERAL INFORMATION

Stackback Charts

- The Stackback charts account for the typical stacking of the scissor track. As with any textile product, some variation is typical.
- On side stack shadings, include in your uncovered width measurement the desired amount of fabric overlap on the side opposite the fabric stack.
- Moving wand is not available in a split stack configuration.

OUTSIDE MOUNT

Side Stack		
Uncovered Width Up To	Stackback Up To	Ordered Width
5 ³ / ₈ "	7 ³ / ₈ "	12 ³ / ₄ "
7 ³ / ₄ "	7 ⁷ / ₈ "	15 ⁵ / ₈ "
10 ¹ / ₈ "	8 ³ / ₈ "	18 ¹ / ₂ "
12 ¹ / ₂ "	8 ⁷ / ₈ "	21 ³ / ₈ "
14 ⁷ / ₈ "	9 ³ / ₈ "	24 ¹ / ₄ "
17 ¹ / ₄ "	9 ⁷ / ₈ "	27 ¹ / ₈ "
19 ⁵ / ₈ "	10 ³ / ₈ "	30"
22"	10 ⁷ / ₈ "	32 ⁷ / ₈ "
24 ³ / ₈ "	11 ³ / ₈ "	35 ³ / ₄ "
26 ³ / ₄ "	11 ⁷ / ₈ "	38 ⁵ / ₈ "
29 ¹ / ₈ "	12 ³ / ₈ "	41 ¹ / ₂ "
31 ¹ / ₂ "	12 ⁷ / ₈ "	44 ³ / ₈ "
33 ³ / ₄ "	13 ³ / ₈ "	47 ¹ / ₈ "
36 ¹ / ₈ "	13 ⁷ / ₈ "	50"
38 ¹ / ₂ "	14 ³ / ₈ "	52 ⁷ / ₈ "
40 ⁷ / ₈ "	14 ⁷ / ₈ "	55 ³ / ₄ "
43 ¹ / ₄ "	15 ³ / ₈ "	58 ⁵ / ₈ "
45 ⁵ / ₈ "	15 ⁷ / ₈ "	61 ¹ / ₂ "
48"	16 ³ / ₈ "	64 ³ / ₈ "
50 ³ / ₈ "	16 ⁷ / ₈ "	67 ¹ / ₄ "
52 ³ / ₄ "	17 ³ / ₈ "	70 ¹ / ₈ "
55 ¹ / ₈ "	17 ⁷ / ₈ "	73"
57 ¹ / ₂ "	18 ³ / ₈ "	75 ⁷ / ₈ "
59 ⁷ / ₈ "	18 ⁷ / ₈ "	78 ³ / ₄ "
62 ¹ / ₈ "	19 ³ / ₈ "	81 ¹ / ₂ "
64 ¹ / ₂ "	19 ⁷ / ₈ "	84 ³ / ₈ "
66 ⁷ / ₈ "	20 ³ / ₈ "	87 ¹ / ₄ "
69 ¹ / ₄ "	20 ⁷ / ₈ "	90 ¹ / ₈ "
71 ⁵ / ₈ "	21 ³ / ₈ "	93"
74"	21 ⁷ / ₈ "	95 ⁷ / ₈ "
76 ³ / ₈ "	22 ³ / ₈ "	98 ³ / ₄ "
78 ³ / ₄ "	22 ⁷ / ₈ "	101 ⁵ / ₈ "
81 ¹ / ₈ "	23 ³ / ₈ "	104 ¹ / ₂ "
83 ¹ / ₂ "	23 ⁷ / ₈ "	107 ³ / ₈ "

Please Note:

- The maximum uncovered width of side stack sheers is 153¹/₈".
- Include in your uncovered width measurement the desired amount of fabric overlap on the side opposite the fabric stack.

Uncovered Width Up To	Stackback Up To	Ordered Width
85 ⁷ / ₈ "	24 ³ / ₈ "	110 ¹ / ₄ "
88 ¹ / ₄ "	24 ⁷ / ₈ "	113 ¹ / ₈ "
90 ⁵ / ₈ "	25 ³ / ₈ "	116"
92 ⁷ / ₈ "	25 ⁷ / ₈ "	118 ³ / ₄ "
95 ¹ / ₄ "	26 ³ / ₈ "	121 ⁵ / ₈ "
97 ⁵ / ₈ "	26 ⁷ / ₈ "	124 ¹ / ₂ "
100"	27 ³ / ₈ "	127 ³ / ₈ "
102 ³ / ₈ "	27 ⁷ / ₈ "	130 ¹ / ₄ "
104 ³ / ₄ "	28 ³ / ₈ "	133 ¹ / ₈ "
107 ¹ / ₈ "	28 ⁷ / ₈ "	136"
109 ¹ / ₂ "	29 ³ / ₈ "	138 ⁷ / ₈ "
111 ⁷ / ₈ "	29 ⁷ / ₈ "	141 ³ / ₄ "
114 ¹ / ₄ "	30 ³ / ₈ "	144 ⁵ / ₈ "
116 ⁵ / ₈ "	30 ⁷ / ₈ "	147 ¹ / ₂ "
119"	31 ³ / ₈ "	150 ³ / ₈ "
121 ¹ / ₄ "	31 ⁷ / ₈ "	153 ¹ / ₈ "
123 ⁵ / ₈ "	32 ³ / ₈ "	156"
126"	32 ⁷ / ₈ "	158 ⁷ / ₈ "
128 ³ / ₈ "	33 ³ / ₈ "	161 ³ / ₄ "
130 ³ / ₄ "	33 ⁷ / ₈ "	164 ⁵ / ₈ "
133 ¹ / ₈ "	34 ³ / ₈ "	167 ¹ / ₂ "
135 ¹ / ₂ "	34 ⁷ / ₈ "	170 ³ / ₈ "
137 ⁷ / ₈ "	35 ³ / ₈ "	173 ¹ / ₄ "
140 ¹ / ₄ "	35 ⁷ / ₈ "	176 ¹ / ₈ "
142 ⁵ / ₈ "	36 ³ / ₈ "	179"
145"	36 ⁷ / ₈ "	181 ⁷ / ₈ "
147 ³ / ₈ "	37 ³ / ₈ "	184 ³ / ₄ "
149 ³ / ₄ "	37 ⁷ / ₈ "	187 ⁵ / ₈ "
152"	38 ³ / ₈ "	190 ³ / ₈ "
153 ¹ / ₈ "	38 ⁷ / ₈ "	192"

Split Stack		
Uncovered Width Up To	Stackback Up To	Ordered Width
7 ³ / ₈ "	4 ¹ / ₂ " (x 2)	16 ³ / ₈ "
12 ¹ / ₈ "	5" (x 2)	22 ¹ / ₈ "
16 ⁷ / ₈ "	5 ¹ / ₂ " (x 2)	27 ⁷ / ₈ "
21 ⁵ / ₈ "	6" (x 2)	33 ⁵ / ₈ "
26 ³ / ₈ "	6 ¹ / ₂ " (x 2)	39 ³ / ₈ "
31"	7" (x 2)	45"
35 ³ / ₄ "	7 ¹ / ₂ " (x 2)	50 ³ / ₄ "
40 ¹ / ₂ "	8" (x 2)	56 ¹ / ₂ "
45 ¹ / ₄ "	8 ¹ / ₂ " (x 2)	62 ¹ / ₄ "
50"	9" (x 2)	68"
54 ³ / ₄ "	9 ¹ / ₂ " (x 2)	73 ³ / ₄ "
59 ¹ / ₂ "	10" (x 2)	79 ¹ / ₂ "
64 ¹ / ₈ "	10 ¹ / ₂ " (x 2)	85 ¹ / ₈ "
68 ⁷ / ₈ "	11" (x 2)	90 ⁷ / ₈ "
73 ⁵ / ₈ "	11 ¹ / ₂ " (x 2)	96 ⁵ / ₈ "
78 ³ / ₈ "	12" (x 2)	102 ³ / ₈ "
83 ¹ / ₈ "	12 ¹ / ₂ " (x 2)	108 ¹ / ₈ "
87 ⁷ / ₈ "	13" (x 2)	113 ⁷ / ₈ "
92 ¹ / ₂ "	13 ¹ / ₂ " (x 2)	119 ¹ / ₂ "
97 ¹ / ₄ "	14" (x 2)	125 ¹ / ₄ "
102"	14 ¹ / ₂ " (x 2)	131"
106 ³ / ₄ "	15" (x 2)	136 ³ / ₄ "
111 ¹ / ₂ "	15 ¹ / ₂ " (x 2)	142 ¹ / ₂ "
116 ¹ / ₄ "	16" (x 2)	148 ¹ / ₄ "
120 ⁷ / ₈ "	16 ¹ / ₂ " (x 2)	153 ⁷ / ₈ "
125 ⁵ / ₈ "	17" (x 2)	159 ⁵ / ₈ "
130 ³ / ₈ "	17 ¹ / ₂ " (x 2)	165 ³ / ₈ "
135 ¹ / ₈ "	18" (x 2)	171 ¹ / ₈ "
139 ⁷ / ₈ "	18 ¹ / ₂ " (x 2)	176 ⁷ / ₈ "
144 ⁵ / ₈ "	19" (x 2)	182 ⁵ / ₈ "
149 ¹ / ₄ "	19 ¹ / ₂ " (x 2)	188 ¹ / ₄ "
152"	20" (x 2)	192"

Please Note:

- The maximum uncovered width of split stack sheers is 152".
- Moving wand system is not available in a split stack configuration.

OVERTONES™ DUAL SHEER SHADES

OVERTONES DUAL SHEER SHADES



The Overtones Dual Sheer Shades are a window shading of unique beauty and performance. The dual panels, with alternating horizontal solid and sheer vanes, add the perfect finishing touch for beautiful luminous windows.

- Overtones Dual Sheer Shades incorporate dual layers of alternating solid and sheer horizontal vanes that can “open and close”.
- In the closed position, the fabric allows softly diffused light and offers full privacy.
- In the open position, the vanes are aligned and light filters through the sheers for gentle illumination.
- The Overtones panels can be raised up and out of sight into the integrated valance.
- The head rail has a matching fabric insert strip and color coordinated cord loop mechanism.
- Overtones Dual Sheer Shades are available to widths of 100” and drops to 120” (fabric dependent) to provide visual elegance to wide windows and doors.
- A Limited Lifetime Warranty serves as a commitment to your satisfaction.

LIFT SYSTEM	UPGRADES	ADD
Cord Loop	Bottom Up	Included

ADDITIONAL OPTIONS	UPGRADES	ADD
Two-On-One Head Rail	Cord Loop Only	Price as two shadings and add together.

MOTORIZED	UPGRADES	ADD	
7.4V Rechargeable PowerTouch Motorization System	Rechargeable with Integrated Battery Pack	\$188	For More Information Page 104
	Plug-In Charger for Rechargeable Li-Ion	\$44	
7.4V Rechargeable Simplicity Motorization System	Motor and Integrated Battery Pack	\$509	For More Information Page 106
	Simplicity 5 Channel Remote	\$65	
	Plug-In Charger for Rechargeable Li-Ion	\$44	
	7.4v Solar Panel	\$168	
Simplicity Smart Controller System	NEO Controller	\$536	For More Information Page 28
	NEO Application for Mobile Devices	FREE	

Shadings wider than 96”: Shadings over 96” in width may require additional fabrication and delivery time.

Overtones™ Dual Sheer Shades
SIZE STANDARDS

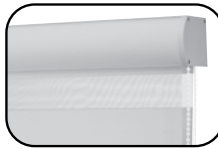

		Overtones		
		Cord Loop	Rechargeable Motorization	
			Simplicity	PowerTouch
ALL FABRICS	Minimum Width	15"	19"	21"
	Minimum Length	24"	20"	20"

				Overtones		
				Cord Loop	Rechargeable Motorization	
					Simplicity	PowerTouch
Translucent	Price Group	Page	Maximum	Width & Length		
Bamboo	27	100	Width & Length	90" x 120"	90" x 120"	90" x 120"
Band	25	99		100" x 120"	100" x 120"	100" x 120"
Band	25	99		100" x 120"	100" x 120"	100" x 120"
Barneгат	24	99		96" x 120"	96" x 120"	96" x 120"
Bistro	27	100		92" x 120"	92" x 120"	92" x 120"
Boutique	27	100		100" x 120"	100" x 120"	100" x 120"
Chevron	27	100		92" x 90"	92" x 90"	92" x 90"
Crepe	23	99		96" x 90"	96" x 90"	96" x 90"
Galaxy	28	100		100" x 120"	100" x 120"	100" x 120"
Heritage	27	100		90" x 100"	90" x 100"	90" x 100"
Herringbone	23	99		102" x 90"	102" x 90"	102" x 90"
Interweave	24	99		90" x 96"	90" x 96"	90" x 96"
Janka	27	100		90" x 90"	90" x 90"	90" x 90"
Marsheen	24	99		102" x 110"	102" x 110"	102" x 110"
Merino	25	99		102" x 90"	102" x 90"	102" x 90"
Merino Wide	25	99		102" x 90"	102" x 90"	102" x 90"
Orion	28	100		100" x 120"	100" x 120"	100" x 120"
Rain	26	100		102" x 90"	102" x 90"	102" x 90"
Silk Strata	25	99		102" x 92"	102" x 92"	102" x 92"
Silver Lining	25	100		100" x 120"	100" x 120"	100" x 120"
Studio	24	99		102" x 110"	102" x 110"	102" x 110"
Valdese	24	99	102" x 106"	102" x 106"	102" x 106"	
Victoria	24	99	102" x 110"	102" x 110"	102" x 110"	
Wave	27	100	102" x 106"	102" x 106"	102" x 106"	

				Overtones		
				Cord Loop	Rechargeable Motorization	
					Simplicity	PowerTouch
Room Darkening	Price Group	Page	Maximum	Width & Length		
Ambrosia	28	100	Width & Length	96" x 100"	96" x 100"	96" x 100"
Brushed	26	100		102" x 96"	102" x 96"	102" x 96"
Essex	26	100		96" x 90"	96" x 90"	96" x 90"
Modish	27	100		90" x 120"	90" x 120"	90" x 120"
Zigzag	26	100		102" x 96"	102" x 96"	102" x 96"

				Overtones	Motorization
More Information On Page				Page 101	Page 104-107

Overtone™ Dual Sheer Shades
FABRIC SPECIFICATIONS

OVERTONES DUAL SHEER SHADES

Pattern Name	Color Band Height	Sheer Band Height	Opacities	Fabric Composition
Ambrosia	4"	~2"	• Room Darkening	• 100% Polyester
Bamboo	4 ⁷ / ₈ "	~2"	• Translucent	• 100% Polyester
Band	2 ³ / ₄ "	~2"	• Translucent	• 100% Polyester
Barnegat	3"	~2"	• Translucent	• 100% Polyester
Bistro	2 ³ / ₄ "	~2"	• Translucent	• 85% Polyester/15% Linen
Boutique	3"	~2"	• Translucent	• 100% Polyester
Brushed	4"	~2"	• Room Darkening	• 100% Polyester
Chevron	3"	~2"	• Translucent	• 100% Polyester
Crepe	3"	~2"	• Translucent	• 100% Polyester
Essex	4"	~2"	• Room Darkening	• 100% Polyester
Galaxy	3"	~2"	• Translucent	• 100% Polyester
Janka	3"	~2"	• Translucent	• 100% Polyester
Heritage	3"	~2"	• Translucent	• 100% Polyester
Herringbone	3 ¹ / ₄ "	~2"	• Translucent	• 100% Polyester
Interweave	4"	~2"	• Translucent	• 100% Polyester
Marsheen	3"	~2"	• Translucent	• 100% Polyester
Merino	3"	~2"	• Translucent	• 100% Polyester
Merino Wide	3 ³ / ₄ "	~2"	• Translucent	• 100% Polyester
Modish	3"	~2"	• Room Darkening	• 100% Polyester
Orion	5 ¹ / ₂ "	~2"	• Translucent	• 100% Polyester
Rain	3 ⁷ / ₈ "	~2"	• Translucent	• 100% Polyester
Silk Strara	3"	~2"	• Translucent	• 100% Polyester
Silver Lining	3"	~2"	• Translucent	• 100% Polyester
Studio	3"	~2"	• Translucent	• 100% Polyester
Valdese	3 ⁵ / ₈ "	~2"	• Translucent	• 100% Polyester
Victoria	3 ³ / ₄ "	~2"	• Translucent	• 100% Polyester
Wave	3 ⁷ / ₈ "	~2"	• Translucent	• 100% Polyester
Zigzag	4"	~2"	• Room Darkening	• 100% Polyester

Overtone™ Dual Sheer Shades

PRICING

OVERTONES DUAL SHEER SHADES

Crepe 3" Translucent Vanes
Herringbone 3¼" Translucent Vanes

PRICE GROUP 23
Cord Loop - Color Coordinated Rails

		Width In Inches													
		24	30	36	42	48	54	60	66	72	78	84	90	96	102
Length In Inches	40	411	449	489	531	569	609	649	688	726	756	808	847	889	928
	50	420	461	503	547	589	630	672	713	756	786	841	882	926	968
	60	431	474	518	564	609	653	696	741	785	816	876	919	965	1009
	70	439	486	532	581	627	674	720	766	812	847	909	955	1004	1050
	80	448	497	546	597	646	695	744	792	841	876	942	990	1041	1089
	90	459	510	561	614	666	717	769	819	870	907	976	1026	1080	1132
	100	468	521	575	631	684	738	791	845	898	936	1009	1062	1119	1171
	110	478	534	591	649	704	761	816	872	928	968	1043	1099	1157	1214
120	488	546	604	664	723	782	840	898	956	998	1076	1134	1195	1253	

Barneget 3" Translucent Vanes
Interweave 4" Translucent Vanes
Marsheen 3" Translucent Vanes
Studio 3" Translucent Vanes
Valdese 3⅝" Translucent Vanes
Victoria 3¾" Translucent Vanes

PRICE GROUP 24
Cord Loop - Color Coordinated Rails

		Width In Inches													
		24	30	36	42	48	54	60	66	72	78	84	90	96	102
Length In Inches	40	473	519	567	616	663	709	757	803	849	884	946	993	1043	1089
	50	485	535	585	638	688	738	789	837	888	924	990	1041	1093	1144
	60	498	552	605	662	715	767	822	874	927	965	1037	1091	1146	1199
	70	511	568	624	683	740	796	853	910	965	1006	1082	1138	1198	1254
	80	523	583	643	705	765	825	885	944	1004	1047	1126	1186	1249	1309
	90	536	600	663	729	791	855	918	981	1043	1088	1173	1236	1301	1364
	100	550	616	682	750	818	884	950	1016	1082	1129	1218	1284	1352	1418
	110	563	633	701	774	844	913	983	1053	1121	1171	1264	1332	1405	1475
120	575	649	721	796	869	942	1014	1087	1159	1211	1309	1381	1456	1529	

Band 2¾" Translucent Vanes
Merino 3" Translucent Vanes
Merino Wide 3¾" Translucent Vanes
Silk Strata 3" Translucent Vanes

PRICE GROUP 25
Cord Loop - Color Coordinated Rails

		Width In Inches													
		24	30	36	42	48	54	60	66	72	78	84	90	96	102
Length In Inches	40	499	554	608	664	717	771	825	880	934	972	1045	1099	1155	1208
	50	517	576	634	696	754	814	872	931	989	1031	1109	1169	1229	1289
	60	536	600	663	730	794	857	921	984	1047	1092	1177	1240	1306	1369
	70	555	622	691	762	831	898	967	1035	1103	1152	1243	1310	1381	1450
	80	572	646	719	794	868	940	1013	1086	1159	1211	1307	1381	1456	1529
	90	592	670	748	828	906	984	1060	1138	1216	1270	1375	1452	1533	1611
	100	610	692	775	860	943	1025	1108	1190	1272	1330	1441	1522	1608	1690
	110	629	717	804	894	981	1068	1155	1243	1330	1390	1507	1594	1683	1772
120	647	740	831	926	1018	1109	1202	1294	1385	1450	1573	1664	1759	1851	

UPGRADES - MOTORIZATION- OPTIONS	MORE INFO
For upgrades, motorization surcharges and options refer to page 97.	Pg 97

Overtone™ Dual Sheer Shades

PRICING

Brushed 4" Room Darkening
 Essex 4" Room Darkening
 Rain 3 7/8" Translucent Vanes
 Zigzag 4" Room Darkening

PRICE GROUP 26
 Cord Loop - Color Coordinated Rails

		Width In Inches													
		24	30	36	42	48	54	60	66	72	78	84	90	96	102
Length In Inches	40	543	604	664	729	790	852	913	975	1035	1079	1161	1221	1286	1348
	50	565	631	699	770	836	903	971	1038	1105	1153	1243	1310	1380	1447
	60	589	662	734	811	885	957	1030	1104	1177	1228	1326	1398	1475	1549
	70	612	691	769	852	931	1009	1088	1167	1247	1302	1408	1487	1569	1648
	80	634	719	804	891	977	1062	1146	1232	1317	1376	1489	1574	1662	1747
	90	658	749	840	934	1025	1115	1206	1297	1388	1451	1573	1664	1757	1848
	100	680	777	874	973	1071	1167	1264	1361	1458	1525	1654	1751	1851	1947
	110	704	807	910	1016	1119	1221	1323	1426	1529	1600	1738	1841	1946	2049
	120	726	835	944	1055	1165	1273	1381	1491	1599	1674	1819	1928	2040	2148

Bamboo 4 7/8" Translucent Vanes
 Bistro 2 3/4" Translucent Vanes
 Boutique 3" Translucent Vanes
 Chevron 3" Translucent Vanes
 Heritage 3" Translucent Vanes
 Janka 3" Translucent Vanes

PRICE GROUP 27
 Cord Loop - Color Coordinated Rails

Modish 3" Room Darkening
 Wave 3 7/8" Translucent Vanes

		Width In Inches													
		24	30	36	42	48	54	60	66	72	78	84	90	96	102
Length In Inches	40	585	658	730	807	880	952	1025	1097	1170	1221	1319	1392	1467	1540
	50	617	697	779	864	944	1025	1107	1187	1269	1326	1434	1515	1599	1681
	60	650	740	829	922	1010	1100	1190	1280	1368	1431	1550	1640	1732	1822
	70	682	779	877	979	1076	1174	1272	1369	1467	1536	1666	1764	1864	1962
	80	713	819	926	1035	1141	1247	1353	1459	1566	1640	1781	1887	1996	2102
	90	746	861	976	1093	1207	1322	1437	1551	1665	1744	1897	2012	2130	2244
	100	778	901	1023	1150	1273	1396	1518	1641	1764	1848	2012	2135	2262	2384
	110	811	943	1074	1208	1339	1470	1602	1732	1864	1954	2130	2260	2395	2526
	120	843	983	1122	1265	1404	1544	1683	1822	1962	2058	2244	2384	2527	2666

Ambrosia 4" Room Darkening
 Galaxy 3" Translucent Vanes
 Orion 5 1/2" Translucent Vanes
 Silver Lining 3" Translucent Vanes

PRICE GROUP 28
 Cord Loop - Color Coordinated Rails

		Width In Inches													
		24	30	36	42	48	54	60	66	72	78	84	90	96	102
Length In Inches	40	637	721	806	894	979	1063	1148	1232	1315	1375	1488	1573	1660	1744
	50	678	773	868	965	1060	1155	1251	1346	1441	1508	1635	1730	1827	1922
	60	720	825	931	1039	1145	1251	1356	1462	1567	1641	1782	1888	1996	2102
	70	759	876	992	1112	1228	1344	1460	1577	1693	1773	1928	2045	2164	2280
	80	799	927	1054	1183	1310	1437	1563	1691	1818	1905	2074	2201	2332	2458
	90	841	979	1116	1257	1394	1532	1669	1806	1945	2039	2222	2359	2501	2638
	100	882	1030	1178	1328	1478	1625	1773	1921	2069	2171	2369	2516	2668	2816
	110	923	1082	1241	1402	1561	1720	1879	2037	2196	2305	2516	2675	2837	2996
	120	964	1133	1302	1475	1644	1813	1983	2152	2321	2437	2663	2832	3005	3174

Product Attributes: Environmental condition, such as heat, humidity, etc. may result in light bowing, puckering and dimpling of the fabric which is considered normal. Some fabrics may lightly fray which is considered normal and within specifications.

Overtones™ Dual Sheer Shades

CORD LOOP HARDWARE SYSTEM

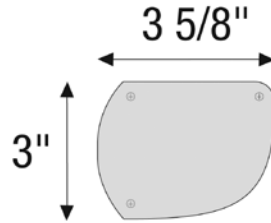

Cord Loop Rail Dimensions

- Depth of cassette: 3 5/8"
- Height of cassette: 3"

Hardware Features	
Hardware colors for all Overtones fabrics	Integrated cassette head rail and bottom rail will be pre-coordinated to the fabric selection. Matching fabric insert is standard. Fabric wrapped bottom rail is standard.
Cord Loop	Cord color will coordinate with your shade fabric.
Mounting Dimensions	Cord Loop Hardware System
Minimum Depth Inside Mount (shallow mount)	1 1/2"
Minimum Depth Flush Inside Mount including brackets	3 3/4"
Minimum Surface Outside Mount	1 1/2"
Finished Dimensions	
Inside Mount	
	<ul style="list-style-type: none"> • Fabric will measure ordered width less: 1 1/4" • Fabric will measure ordered length • Head rail* will measure ordered width less: 1/4" • Tube will measure ordered width less: 1 1/8" • Bottom rail outer width will measure ordered width less: 1 3/16" • Bottom rail inner width will measure ordered width less: 1 3/8"
Outside Mount	
	<ul style="list-style-type: none"> • Fabric will measure ordered width less: 1" • Fabric will measure ordered length • Head rail will measure ordered width • Tube will measure ordered width less: 7/8" • Bottom rail outer width will measure ordered width less: 15/16" • Bottom rail inner width will measure ordered width less: 1 1/8"
	<p>* Head rail measurements includes plastic endcaps.</p> <p>Length Considerations: Comfortex will fabricate your Overtones Sheer Shades to the exact length ordered, plus or minus 1/8". The vanes will be in the closed position when the shade is at its full ordered length as seen in Figure B on page 102.</p>

Information for Ordering

- Follow basic measuring instructions
- Specify left or right cord loop
- Extension brackets and spacers are available at no extra charge
- Specify hold down brackets if required
- Side mount brackets are NOT available

Measuring Instructions

See page 110 for measuring instructions.

Child Safety

See page 111 for child safety information.

Limited Lifetime Warranty

See page 113 for warranty information.

Overtones™ Dual Sheer Shades CORD LOOP HARDWARE SYSTEM

Applications

- Standard Rectangular

Overtones Dual Sheer Shades Specifications

Once ordered and manufactured, the width of the Overtones fabric cannot be altered. Comfortex makes deductions to the width of Overtones Dual Sheer Shades depending on the type of mounting indicated. For all mounting types, the fabric will measure exactly the length ordered when the shade is fully lowered and the vanes are in the closed position.

Loop Cord Information

Overtones Dual Sheer Shades utilize a looped cord to operate the shade. The cord color will coordinate with your shade fabric. The cord loops will measure the length indicated below from 2 feet to 8 feet at 1 foot intervals unless otherwise specified. Lengths over 6 feet available in white only.

Shade Height	Standard Loop
24" to 39 ⁷ / ₈ "	2' (24")
40" to 59 ⁷ / ₈ "	3' (36")
60" to 83 ⁷ / ₈ "	4' (48")
84" to 107 ⁷ / ₈ "	5' (60")
108" to 120"	6' (72")

Side By Side Alignment

When Overtones Dual Sheer Shades are installed side-by-side, vane alignment can be guaranteed within ¼" only if:

- The shades are the same color and ordered at the same time.
- The sum total of the widths of all shades needing alignment is less than the maximum shade width of the fabric style ordered. See page 97.
- Side-by-side lineup is specified when the order is placed.

Cleaning and Care of Overtones Fabrics

Overtones fabric is made from a sturdy, woven polyester fabric which can be feather dusted or vacuumed at a low setting. Spots or stains can be lightly rubbed clean with a damp sponge and mild soap. To avoid discoloration of the material, we recommend against the use of chemical cleaners.

For additional care and cleaning information, please contact the Comfortex Technical Services Department at 800-843-4151.

Operation

Overtones Dual Sheer Shades incorporate dual layers of alternating solid and sheer horizontal vanes. By aligning the sheer or the solid portion of the fabric, you can control the amount of light that enters the room.



Figure A

The dual layers of solid and sheer horizontal vanes continually cross over each other as the shade is raised or lowered. This allows users to control the amount of incoming light and the view-through effect with the shade partially raised at various points throughout the window as seen in Figure A.

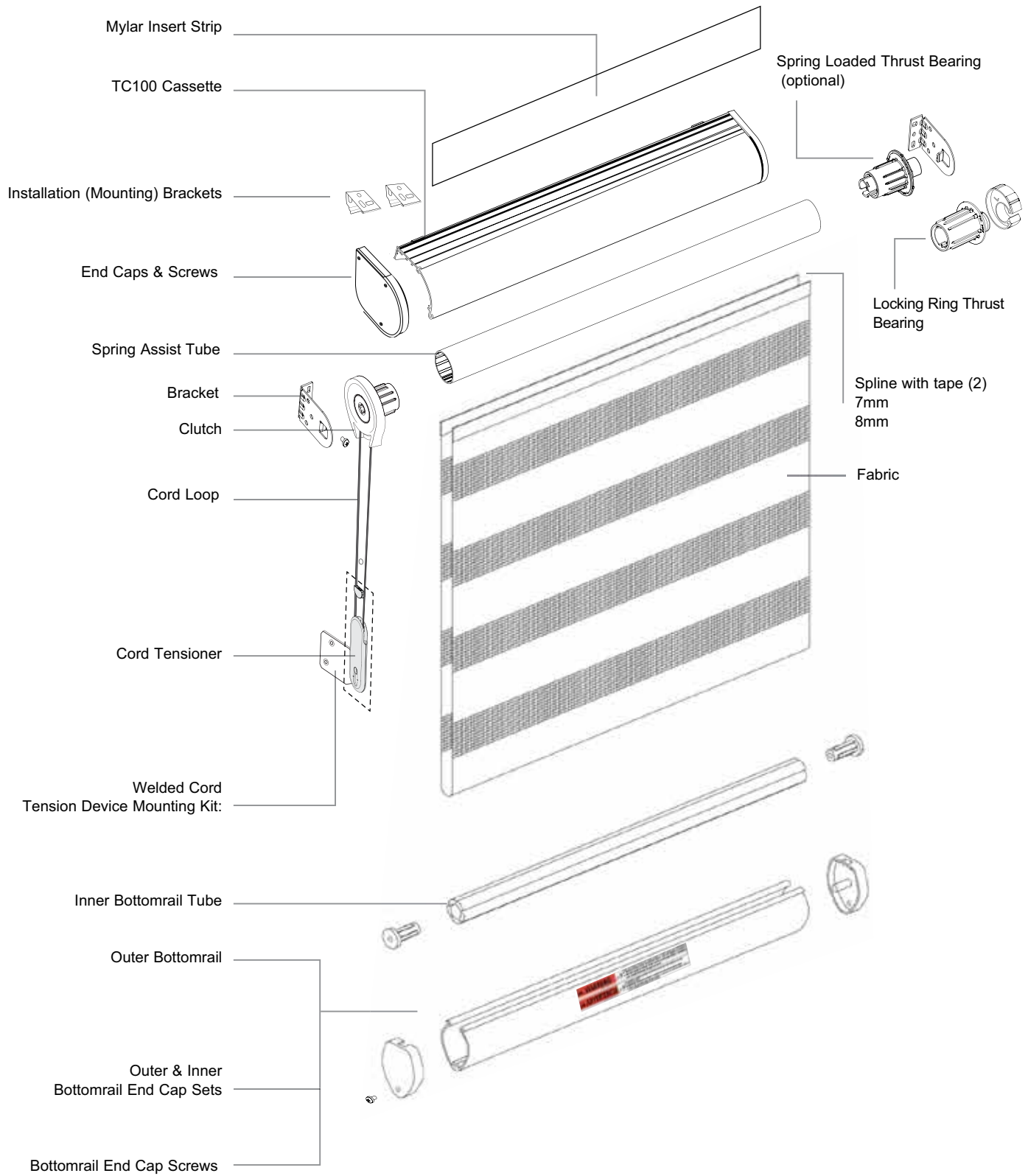

Figure B

When the Overtones Shade is fully lowered, the vanes are overlapped.

When in the closed position, Overtones fabric diffuses incoming light, providing a warm glow. The vanes will be in the closed position when the shade is at its full ordered length as seen in Figure B.

Overtone™ Dual Sheer Shades CORD LOOP HARDWARE SYSTEM



Overtone™ Dual Sheer Shades

7.4V RECHARGEABLE POWERTOUCHE HARDWARE SYSTEM | DESIGNER CASSETTE HEAD RAIL

VERTONES DUAL SHEER SHADES

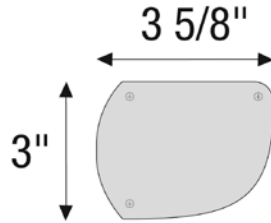
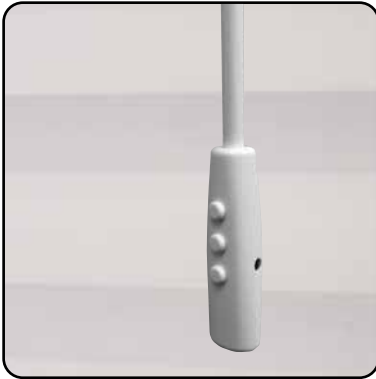

Cord Loop Rail Dimensions

- Depth of cassette: 3 5/8"
- Height of cassette: 3"

Hardware Features

Hardware colors for all Overtone fabrics	Integrated cassette head rail and bottom rail will be pre-coordinated to the fabric selection. Matching fabric insert is standard. Fabric wrapped bottom rail is standard.
Wand & Pendant	White

Mounting Dimensions

Simplicity Motorized Hardware System

Minimum Depth Inside Mount (shallow mount)	1 1/2"
Minimum Depth Flush Inside Mount including brackets	3 3/4"
Minimum Surface Outside Mount	1 1/2"

Finished Dimensions

Inside Mount

	<ul style="list-style-type: none"> • Fabric will measure ordered width less: 1 1/4" • Fabric will measure ordered length • Head rail* will measure ordered width less: 1/4"* • Tube will measure ordered width less: 1 1/8" • Bottom rail outer width will measure ordered width less: 1 3/16" • Bottom rail inner width will measure ordered width less: 1 3/8"
--	--

Outside Mount

	<ul style="list-style-type: none"> • Fabric will measure ordered width less: 1" • Fabric will measure ordered length • Head rail will measure ordered width • Tube will measure ordered width less: 7/8" • Bottom rail outer width will measure ordered width less: 1 5/16" • Bottom rail inner width will measure ordered width less: 1 1/8"
--	---

	<p>* Head rail measurements includes plastic endcaps.</p> <p>Length Considerations: Comfortex will fabricate your Overtone Sheer Shades to the exact length ordered, plus or minus 1/8". The vanes will be in the closed position when the shade is at its full ordered length..</p>
--	---

Overtones™ Dual Sheer Shades

7.4V RECHARGEABLE POWERTOUCH HARDWARE SYSTEM | DESIGNER CASSETTE HEAD RAIL

PowerTouch™ Rechargeable Shades

Sheer Shadings can be fabricated with the PowerTouch Rechargeable Push Button Control option. The PowerTouch Rechargeable option is an easy, cord free motorized operation for the budget savvy homeowner. PowerTouch Rechargeable uses Simplicity motors and components.

PowerTouch Rechargeable Shades Operation

Press the up or down button on the pendant to raise or lower the shading to your desired position.

No programming is required with PowerTouch™, all programming is set at the factory. Upper and lower limits easily can be adjusted in the field if desired. Favorites position can be programmed on-site. Please refer to the installation instructions at comfortex.com/comfortex-dealers.

PowerTouch Rechargeable Surcharges

See page 97.

PowerTouch Appearance

- The PowerTouch Rechargeable wand and pendant is attached to the head rail and requires no additional mounting.
- The wand and pendant hangs down the front of the shades from the head rail. The wand does not touch the fabric.
- Pendant is 2½" long.



PowerTouch Rechargeable Color Options

- Shadings with Black or Oil Rubbed Bronze hardware will be built with black wand and pendants standard. All other colors will use white wand and pendants.

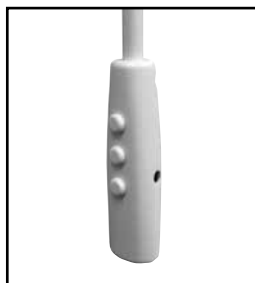

White



Black Shown with Plug-In Charger

PowerTouch Wand and Pendant Location

The standard location for the wand and pendant is on the right. Please specify location when ordering.

PowerTouch Rechargeable Wand Length

Size and color must be specified when ordered. Below is a recommended size chart.

Shading Length	Standard Wand Length
Up to 30"	1' (12")
>30" to 52"	2' (24")
>52" to 78"	3' (36")
>78" to 100"	4' (48")
>100" to 120"	5' (60")

- Wand length is in 1 foot increments. 1 foot - 5 foot

Mounting Requirements for PowerTouch Rechargeable Shadings

- No special installation hardware or wiring requirements are needed.
- The wand and pendant do not need to be mounted to operate the shading.

PowerTouch Rechargeable Battery Life

The battery life will vary based on the type of window covering selected, the size and weight of the window covering and the number of times you operate the blind on a daily basis.

Battery Charger

8.4 Volt charger requires a standard power outlet to recharge the battery. Must specify charger when ordering a Simplicity PowerTouch Rechargeable Shading. The charger plugs into the charger port. The charger is black and comes with a 156" wire. The dimensions are 1" wide x 2½" length x 1¾" deep.



PowerTouch Rechargeable Shadings Warranty

Please see page 114 for complete warranty information.

NEW Simplicity Bluetooth Motorization

Learn about Simplicity Bluetooth motorization and Comfortex FREE Color Lux Mobile App on page 18.

Overtones™ Dual Sheer Shades
7.4V RECHARGEABLE SIMPLICITY HARDWARE SYSTEM

VERTICAL OVERTONES DUAL SHEER SHADES

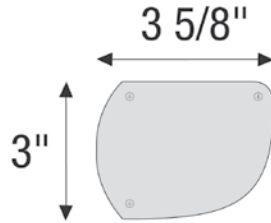

Cord Loop Rail Dimensions

- Depth of cassette: 3⁵/₈"
- Height of cassette: 3"

Hardware Features

Hardware colors for all Overtones fabrics	Integrated cassette head rail and bottom rail will be pre-coordinated to the fabric selection. Matching fabric insert is standard. Fabric wrapped bottom rail is standard.
Wand & Pendant	White

Mounting Dimensions

Rechargeable Simplicity Motorization Hardware System

Minimum Depth Inside Mount (shallow mount)	1 1/2"
Minimum Depth Flush Inside Mount including brackets	3 3/4"
Minimum Surface Outside Mount	1 1/2"

Finished Dimensions

Inside Mount

	<ul style="list-style-type: none"> • Fabric will measure ordered width less: 1 1/4" • Fabric will measure ordered length • Head rail* will measure ordered width less: 1/4"* • Tube will measure ordered width less: 1 1/8" • Bottom rail outer width will measure ordered width less: 1 3/16" • Bottom rail inner width will measure ordered width less: 1 3/8"
--	--

Outside Mount

	<ul style="list-style-type: none"> • Fabric will measure ordered width less: 1" • Fabric will measure ordered length • Head rail will measure ordered width • Tube will measure ordered width less: 7/8" • Bottom rail outer width will measure ordered width less: 1 5/16" • Bottom rail inner width will measure ordered width less: 1 1/8"
--	---

* Head rail measurements includes plastic endcaps.
Length Considerations: Comfortex will fabricate your Overtones Dual Sheer Shades to the exact length ordered, plus or minus 1/8". The vanes will be in the closed position when the shade is at its full ordered length.

Overtones™ Dual Sheer Shades

7.4V RECHARGEABLE SIMPLICITY HARDWARE SYSTEM

Simplicity Rechargeable Motors

The Rechargeable Simplicity Motor program features an integrated rechargeable lithium ion battery in the motor casing and is fully concealed by the roller tube.

Simplicity Rechargeable Motors

No special installation hardware or wiring requirements are needed to install motorized Shangri-La Shadings with Designer Cassette Head Rail. No external battery wand is required.

Rechargeable Simplicity Motor Batteries

The battery for the integrated rechargeable simplicity motor system is integrated within the motor casing and is fully concealed by the roller tube.

Rechargeable battery comes fully charged from the factory.

Integrated Rechargeable Motor Battery Life

Rechargeable battery is included with the motor.

The average battery charge will last 6-12 months based on an average sized shade raised and lowered once per day. The life of the battery charge will vary based on the type of window covering selected, the size and weight of the window covering and the number of times the shade is operated on a daily basis.



Charging Port

The battery can be recharged up to 500 times. It takes approximately 5 hours to recharge the motor when fully depleted.

Integrated Rechargeable Motor Battery Charger

An 8.4 Volt charger requires a standard power outlet to recharge the battery. The charger must be specified when ordering an Integrated Rechargeable Simplicity Motorized shade. The charger plugs into the charging port of the motor. Required with Integrated Shading order. Sold separately.



The charger is black and comes with a 156" wire. The dimensions are 1" wide x 2½" length x 1¾" deep.

Simplicity Motor Hand Held Remotes

IMPORTANT: Simplicity Rechargeable Motorized Shadings are programmed at the factory with the "up and down" limits. The shades are **UNLINKED** from the remote so they are not able to operate during shipping. Each shade should be installed **before** linking it to the remote.

5 Channel Remote

The **5 Channel (5C) remote** can operate up to five shadings simultaneously, individually or in groups.

Simplicity (5C) remotes and holders are black in color. The remote comes with a holder which can be mounted to a wall for easy storage. The range of the remote is approximately 80 feet.



Please Note:

- Not all motors run at the same rate of speed.
- Simplicity motors have a "Favorites" or "MY" position setting. If the homeowner wants to set several shadings at the same intermediate position, follow instructions provided with installation manual.
- **WHEN ORDERING THE NEW INTEGRATED RECHARGEABLE, PLEASE ORDER THE NECESSARY BATTERY CHARGER.**

Important Information about Integrated Rechargeable Simplicity Motor Shading Operation and Installation

- Simplicity Motorized Shadings installed into windows with metal casings may have a reduced radio frequency range, or may not operate at all, depending control.
- Be mindful of when your shade starts to slow down during operation. It is a good indicator the shade needs to be recharged.

Simplicity Battery Operated Motorized Shadings Warranty

Please see page 114 for complete Comfortex warranty information.

Sheer Horizontal Window Shadings

GENERAL INFORMATION

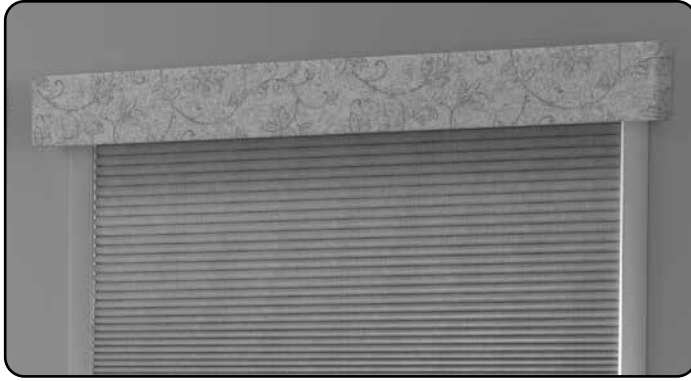

Highlights Cornice Valances

Elevate your windows to a whole new level of design with the Highlights Cornice Valance. Coordinate with other design elements in your room and add a finishing touch to the top of any window treatment. The Highlights Cornice Valance is versatile and beautiful at a price point that won't leave you wondering how to cover the rest of your windows!

Choose from any color in the Color Lux Roller line and customize the valance with our 7 available return sizes to best fit your application.

Easy assembly and quick installation, with the Highlights Cornice Valance, more beautiful windows are within your reach.



GENERAL INFORMATION

Sheer Horizontal Window Shadings

GENERAL INFORMATION

Color Lux Sheer Shadings, Shangri-La Sheer Shadings, Paradise Sheer Shadings, and Overtones Dual Sheer Shades

Cleaning and Care

Shangri-La, Paradise, Overtones and Soft Tones Sheer Shadings are made from a sturdy, knitted polyester fabric which can be feather dusted or vacuumed at a low setting. Spots or stains can be lightly rubbed clean with a damp sponge and mild soap. To avoid discoloration of the material, we recommend against the use of chemical cleaners.

Precautions should be taken to reduce exposure to harsh environmental elements, such as salt air. Continuous exposure to salt air through open windows and doors will accelerate fabric deterioration over time.

Important: Do not clean the fabric using electrostatic wipes such as Swiffer® or Pledge Grab-It®.

Ultrasonic Cleaning

Color Lux Sheer Shadings, Shangri-La, Paradise, and OverTones Sheer Shadings can be ultrasonically cleaned. Adco OnSite Fabricare provides shading and blind cleaning services. For more information, visit www.onsitefabricare.com. Comfortex acknowledges these cleaning methods as being safe and effective. We cannot attest to the quality of equipment or services provided by any independent cleaning facility.

For additional advice on care or cleaning, please contact the Comfortex Technical Service Department at 800-843-4151.

Scotchgard™ Treated Shades

The following are the recommended cleaning and care instructions for window treatments with fabric treated with Scotchgard™ Protector.

- Gently blot liquid stains immediately with a clean, white cloth.
- If stain remains, prepare a solution of ¼ teaspoon of clear, non-bleaching dish detergent mixed with 1 cup of lukewarm water. Dampen a clean white cloth and gently blot the stain.
- Do not over wet the fabric or excessively rub the stained area.
- See the Installation and Care instructions for complete details.

For additional assistance with stain removal, call the Scotchgard™ Protector Service Center at 1-800-433-3296. Customer Care representatives are available Monday through Friday, 8am to 6pm CT.

Vertical Sheer Shadings Cleaning and Care

The Vertical Sheer Shadings sheer, valance, and vane fabric are 100% polyester. They are resilient, anti-static, and dust resistant.

As part of the final step of installation, light steaming may be required. Steam the sheer so its contours are round, full and free of wrinkles; use short vertical strokes and steam from behind whenever possible.

Feather dusting or light vacuuming is usually all the customer needs to do to keep the sheer looking good.

Shadings can be spot cleaned any using a clothing pre-treatment solution. Blot the soiled area as you support it from behind with another cloth. Let dry, then blot with distilled or bottled water to rinse.

Ultrasonic Cleaning

For deep cleaning, both injection/extraction and ultrasonic cleaning methods are recommended for Vertical Sheer Shadings. Adco OnSite Fabricare provides shading and blind cleaning services. For more information, visit www.onsitefabricare.com. Comfortex acknowledges these cleaning methods as being safe and effective. We cannot attest to the quality of equipment or services provided by any independent cleaning facility.

For additional advice on care or cleaning, please contact the Comfortex Technical Service Department at 800-843-4151.

Sheer Horizontal Window Shadings

GENERAL INFORMATION

Sheer Shadings

MEASURING INSTRUCTIONS

Important Measuring Guidelines for Sheer Shadings, Soft Tones, Vertical Sheer Shadings. Comfortex accepts measurements down to 1/16" increments.

Precise width and length measurements are critical. Fabric width cannot be altered after the shading is fabricated.

Please use a metal tape measure for accuracy.

The head rail must be installed perfectly level to ensure smooth operation. On an inside mount, it is recommended that you check to see that the mounting surface is level and consistent. If your soffit needs to be leveled, this should be done before measuring.

Inside Mount

Measure across the width of your window opening in three different places - top, middle and bottom. Measurements should be taken within the window jamb. Provide the smallest of the three measurements to Comfortex. Be exact. Comfortex will make the necessary deductions to fit the window opening.

Measure the length of the window opening from the underside of the soffit to the surface of the window sill in two places - use the smallest of these two measurements.

Outside Mount

Measure the exact width and length of the area to be covered. On the width, allow at least 1 1/2" of an overlap on each side. An overlap of 3" on each side is recommended. Be sure to take into consideration any obstructions such as window trim, molding, locks and window cranks.

Side Mount

Side mount is not available with DoorStyles Shadings.

Shangri-La may be side mounted using "L" brackets. For side mounts, follow the instructions for inside mounts. An additional 1/2" will be taken off the standard inside mount deduction to allow room for the "L" brackets.

The maximum shading width utilizing the side mount option is 48".

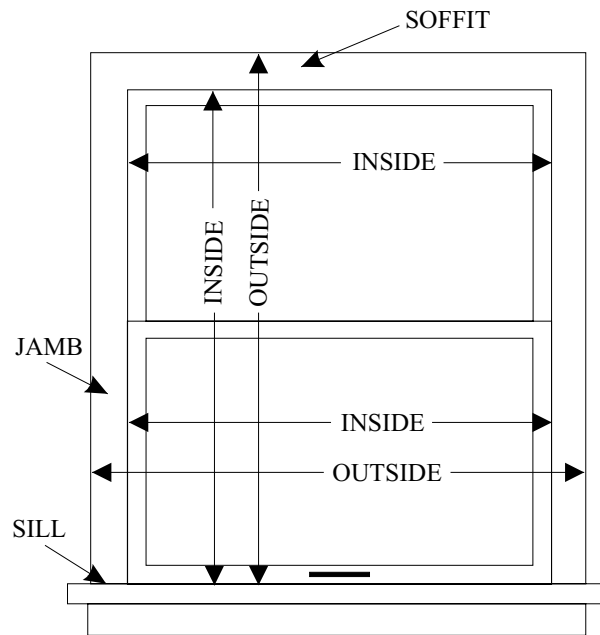

GENERAL INFORMATION

Sheer Horizontal Window Shadings

GENERAL INFORMATION

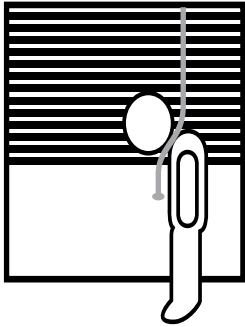
⚠️ WARNING	⚠️ ADVERTENCIA
 <p>Window Blind Cord Can STRANGLE Your Child.</p> <p>To prevent strangulation, purchase cordless products or products with inaccessible cords.</p>	<p>La cuerda ciega de la ventana puede ESTRANGULAR su niño.</p> <p>Para evitar el estrangulamiento, compre alternativas inalámbricas o productos con cables inaccesibles.</p>

Child Safety

All Comfortex products have been fully tested and proven to comply with the current WCMA Standards for Safety of Window Covering Products.

Be aware that it is possible for children to become entangled in window covering cords. To reduce the risk of accidents, all cords must be kept out of the reach of children.

Cord Tensioners

Cord tensioners used on Shangri-La and Soft Tones Shadings continuous cord loops keep the continuous cord loops taut to prevent children and pets from becoming entangled and subsequently injuring themselves. Cord tensioners must be used with Shangri-La and Soft Tones Shadings to comply with the Consumer Product Safety Commission (CPSC) and WCMA Child Safety Guidelines.

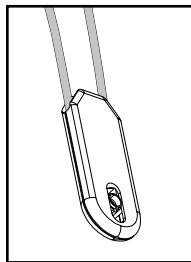

Cord Tensioner

Shangri-La Shadings with Retractable Cord Hardware

Retractable Cord hardware is safe alternative to conventional cord loop controls by retracting and limiting the cord length. We recommend using cord cleats.

Vertical Sheer Shadings

The combination wand/cord option integrates both tilt and traverse functions into one easy-to-use control that keeps the cord taut. The moving wand option used on Vertical Sheer Shadings allows all functions to be controlled by a single wand without the need for operating cords.

Sheer Horizontal Window Shadings

GENERAL INFORMATION

Conditions of Sale

All Comfortex products are custom fabricated to your exact specifications. We cannot accept responsibility for errors in ordering or cancellations and charges after the order is in production.

Policies

Our policies are designed to provide a guide for doing business with Comfortex and are subject to change. Our first priority and number one policy is to provide the highest level of service and total satisfaction.

Freight Policy - Effective January 18, 2021

Fabricated Shades/Blinds

Comfortex will ship all orders for fabricated shades or blinds freight free via FedEx UPS Ground or other similar method within the Continental United States.

A transportation surcharge of \$8 per unit will be added to all fabricated product orders shipping within the Continental U.S. with a minimum charge of \$25 per order.

The applicable fee will be the higher figure of the per unit charge and the minimum charge. For example, if you order four shades, you will be charged a total of \$32 for shipping (4 units x \$8 per unit). If you order two shades, you will be charged a total of \$25 for shipping (\$25 minimum cost).

Color Lux "Green Fabric" made to exact size will incur a \$2.50 per unit transportation surcharge. In addition to the \$2.50 fee, fabrics 90" wide or greater will also incur a \$50 per order oversize fee.

This rate structure will apply to shades/blinds, vane packs, individual vanes, tracks, verticals, valances, and cut yardage orders.

The following are the exceptions:

Oversized Shipments (widths of 90 inches or greater): In addition to the \$8 transportation surcharge per unit, (minimum of \$25), a \$50 per unit Common Carrier surcharge will be added to all oversized fabricated products shipping within the Continental U.S., including shades/blinds, Vertical Sheer Shadings, Ovation Cellular Slider, Panel Track systems, valances, vane packs, individual vanes, and tracks. Oversized products will have a minimum charge of \$80 per order.

Hawaii and Alaska: Shipments to Hawaii and Alaska will incur transportation surcharges of \$27 per unit. In addition, a \$140 per unit Common Carrier surcharge for oversized shades/blinds (over 90") and an \$80 per order oversize fee for Cut Fabric orders over 90" will be added to orders shipping to these two states.

Canada (all amounts are USD): Shipments to Canadian dealers will incur an \$8.75 per unit transportation surcharge. There will also be an overall minimum charge of \$25 per order. In addition, an \$80 per unit Common Carrier surcharge for oversized shades/blinds (90" or greater) and a \$40 per order oversize fee for Cut Fabric orders 90" or greater will be added to orders shipping to Canada.

Other Countries: All Dealers requesting orders to be shipped outside the United States must provide a Freight Forwarder.

Components and Fabric

Comfortex will prepay all freight charges on shipments of component and fabric orders over \$3,500 in value within the Continental US. Fabric and component orders less than \$3,500 will be subject to freight charges.

Charged Marketing Materials

All charged marketing materials will incur freight charges. **EXCEPTION:** Manufacturer's Price List and Reference Guides and Price List Binders will ship freight free. Marketing materials may ship on separate days, from different locations. Freight charges are calculated per package, not per order.

Specifications

All Comfortex products are designed and tested to perform as intended within established, published parameters. Requests for "custom fabrication" of products outside of our published specifications may be considered, but are at the discretion of the Comfortex Technical Services department. Restrictions and additional charges apply.

Download installation instructions, order forms or additional price list copies on the Comfortex OnDemand Library or www.comfortex.com/comfortex-dealers in the Dealers Resource Center.

Sheer Horizontal Window Shadings

GENERAL INFORMATION

Sheer Horizontal & Vertical Shadings Warranty Information

Knitted fabric may experience minor weave variations due to heat, humidity and other room conditions. These variations can result in light bowing, puckering and dimpling of the Shangri-La material. This is considered normal and does not constitute a failure in either workmanship or materials. The possible variations are minor and have been shown through case study not to detract from the beauty of the product.

Warranty Information Regarding the Braided Cord on Shangri-La Sheer Shadings and Soft Tones Shadings with Designer Cassette Hardware:

Designer Cassette Shadings built with a braided cord do not have a reverse roll stop. If a Shangri-La or Soft Tones Shading with the Designer Cassette Head Rail is raised above 24" in the reverse roll mode, there is a possibility of the fabric rubbing on the head rail. Comfortex reserves the right NOT to warrant wear and tear of fabric if damaged by roll-up in excess of 24".

Shangri-La, Soft Tones, Vertical Sheer Shadings, Paradise Sheer Shadings and Overtones Limited Lifetime Warranty

Comfortex warrants that its window treatments will be free from defects in materials and workmanship for as long as the original residential purchaser owns the product, provided that the product was installed properly and in accordance with the installation instructions. The Limited Lifetime Warranty is extended to the original residential purchaser only, in the original window for which it was installed.

The Warranty does not include any conditions or damages resulting from accidents, alterations, misuse, abuse, misapplication, improper handling, installation, repairs, operation, cleaning, exposure to any and all natural and manufactured excessive heat sources. (Excessive heat sources include, but not limited to; magnification of sun light through cubes of glass, heaters of any kind, ovens, candles, lighting fixtures, etc.) This warranty does not cover variation in fabric color or loss of pleating if product is not being cycled (held in the raised position a portion of the time). Variation in grain or texture in natural wood products is normal. Excessive warping of wood or faux wood slats in high humidity areas are not covered under this warranty. Normal wear and tear is not covered.

All moving parts, such as cords and strings (internal and external), will eventually wear out on all blinds and shades, and fabric may fray. Comfortex considers these things as

normal wear and tear and will carry a five year Limited Warranty.

All fabric, including fabric vanes, panels, inserts, and shades carry a five year Warranty. Fabric cell separation is covered for a lifetime. See Comfortex Standard Return and Repair Policy for more details.

This Limited Warranty does not cover transportation costs to and from the retailer, costs of removal, re-measure, reinstallation of product, or any incidental or consequential damages.

If a Comfortex product is found to be defective in materials or workmanship, we will, at our discretion, repair, replace or refund the cost of a product which fails to conform to this Limited Warranty. Colors vary from lot to lot and may not exactly match sample swatch, sample book, or previous purchases. Discontinued components or color selections will be replaced with the closest equivalent current product. This shall be your sole remedy under this Limited Warranty.

To obtain service, contact the Dealer from whom you purchased the product.

This Warranty is exclusive and in lieu of all other obligations, liabilities or warranties. In no event shall Comfortex or its licensed fabricators or distributors be liable for incidental or consequential damages, or for any other damage, loss or expense, cost or fee associated with such damage. In some states, exclusions for incidental or consequential damages are not allowable. Comfortex Dealers and Fabricators must use safety devices supplied by Comfortex in accordance with Window Covering Safety Counsel guidelines.

This Warranty gives you specific legal rights, and you may also have other rights, which vary from state to state. Policy is subject to change without notice.

This Limited Warranty is exclusive of commercial use. Contact Comfortex Technical Service for more information. No agent, representative, dealer or unauthorized employee has the authority to increase or alter the obligation of this Warranty.

This Limited Warranty supersedes any previous versions.

Sheer Horizontal Window Shadings

GENERAL INFORMATION

Motorized Shadings Warranty

Simplicity Motors including PowerTouch Shadings and Integrated Rechargeable Motorization

We offer a 5 year warranty on all motors and controls. Specifically, we warrant the Simplicity motors and controls to be free from defects in material and workmanship under normal and proper use for a period of 5 years commencing with the date stamped on each product. If the Simplicity product fails within this 5 year period, we will repair or replace it free of charge through your end product supplier. Batteries are not covered by the warranty.

Color Lux Color Warranty

Comfortex utilizes state of the art technology to provide you Color Lux Shades within 2 Delta-E (DE) of the sample fabrics found in the Color Lux Sample Book. When viewed under different lighting sources such as fluorescent, incandescent, halogen, ultraviolet and others, fabrics may appear different to the eye. Comfortex utilizes the worldwide lighting standards of Daylight 65 (D65) as our official standard for measuring and qualifying color accuracy, because D65 daylight bulbs best represent actual "daylight" illumination. Slight color variations (under 2 DE) are within established industry standard and should be expected.

This warranty is in addition to Comfortex limited lifetime warranty.

GENERAL INFORMATION

©2021 COMFORTEX CORPORATION

™ is a trademark of Comfortex Corporation. ® is a registered trademark of Comfortex Corporation. Shangri-La® are registered trademarks of Comfortex Corporation. PowerTouch™ and Omni-View™ are trademarks of Comfortex Corporation. Energizer® is a registered trademark of Energizer Holdings, Inc. Swiffer® is a registered trademark of Procter & Gamble. Pledge Grab-It is a registered trademark of S. C. Johnson & Son, Inc. U.S. and foreign patents pending. The GREENGUARD INDOOR AIR QUALITY CERTIFIED Mark is a registered certification mark used under license through the GREENGUARD Environmental Institute. All rights reserved under license by Comfortex Window Fashions. U.S. and foreign patents pending. All rights reserved.



Midwest
Designer
Supply

1-888-523-2611

**Midwest Designer Supply, Inc.
N30W22377 Green Road Ste C
Waukesha, WI 53186
(262) 523-2600
Fax (262) 524-1007
www.midwestdesignersupply.com**

MDS - your one source for window fashions.